

Camera Operations Guide

Read this first

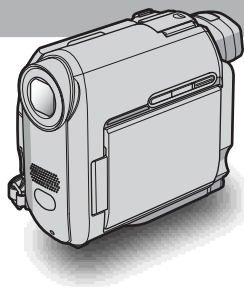

Digital Video Camera Recorder

HANDYCAM

DCR-HC30/HC40

Mini **DV** Digital
Video
Cassette

 **InfoLITHIUM**
SERIES



MEMORY STICK

Read this first

Before operating the unit, please read this manual thoroughly, and retain it for future reference.

WARNING

To prevent fire or shock hazard, do not expose the unit to rain or moisture.

	CAUTION RISK OF ELECTRIC SHOCK DO NOT OPEN	
<p>CAUTION: TO REDUCE THE RISK OF ELECTRIC SHOCK, DO NOT REMOVE COVER (OR BACK). NO USER-SERVICEABLE PARTS INSIDE. REFER SERVICING TO QUALIFIED SERVICE PERSONNEL.</p>		

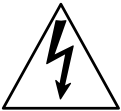

This symbol is intended to alert the user to the presence of uninsulated “dangerous voltage” within the product’s enclosure that may be of sufficient magnitude to constitute a risk of electric shock to persons.



This symbol is intended to alert the user to the presence of important operating and maintenance (servicing) instructions in the literature accompanying the appliance.

Notice

If static electricity or electromagnetic interference causes data transfer to discontinue midway (fail), restart the application or disconnect and connect the USB cable again.

For customers in the U.S.A. and CANADA

CAUTION

TO PREVENT ELECTRIC SHOCK, MATCH WIDE BLADE OF PLUG TO WIDE SLOT, FULLY INSERT.

RECYCLING LITHIUM-ION BATTERIES

Lithium-Ion batteries are recyclable. You can help preserve our environment by returning your used rechargeable batteries to the collection and recycling location nearest you.



For more information regarding recycling of rechargeable batteries, call toll free 1-800-822- 8837, or visit <http://www.rbrbc.org/>

Caution: Do not handle damaged or leaking Lithium-Ion batteries.

“Memory Stick” and battery pack

This device complies with Part 15 of the FCC Rules. Operation is subject to the following two conditions: (1) This device may not cause harmful interference, and (2) this device must accept any interference received, including interference that may cause undesired operation.

This Class B digital apparatus complies with Canadian ICES-003.

For customers in the U.S.A.

If you have any questions about this product, you may call:

Sony Customer Information Center 1-800-222-SONY (7669)

The number below is for FCC related matters only.
Regulatory Information

Declaration of Conformity

Trade Name: SONY

Model No.: DCR-HC30

Responsible Party: Sony Electronics Inc.

Address: 680 Kinderkamack Road, Oradell,
NJ 07649 U.S.A.

Telephone No.: 201-930-6972

This device complies with Part 15 of the FCC Rules.

Operation is subject to the following two conditions:

(1) This device may not cause harmful interference, and (2) this device must accept any interference received, including interference that may cause undesired operation.

Declaration of Conformity

Trade Name: SONY

Model No.: DCR-HC40

Responsible Party: Sony Electronics Inc.

Address: 680 Kinderkamack Road, Oradell,
NJ 07649 U.S.A.

Telephone No.: 201-930-6972

This device complies with Part 15 of the FCC Rules.

Operation is subject to the following two conditions:

(1) This device may not cause harmful interference, and (2) this device must accept any interference received, including interference that may cause undesired operation.

Owner's Record

The model and serial numbers are located on the bottom. Record the serial number in the space provided below. Refer to these numbers whenever you call upon your Sony dealer regarding this product.

Model No. DCR-HC _____

Serial No. _____

Model No.AC- _____

Serial No. _____

CAUTION

You are cautioned that any changes or modifications not expressly approved in this manual could void your authority to operate this equipment.

Note:

This equipment has been tested and found to comply with the limits for a Class B digital device, pursuant to Part 15 of the FCC Rules.

These limits are designed to provide reasonable protection against harmful interference in a residential installation. This equipment generates, uses, and can radiate radio frequency energy and, if not installed and used in accordance with the instructions, may cause harmful interference to radio communications.

However, there is no guarantee that interference will not occur in a particular installation. If this equipment does cause harmful interference to radio or television reception, which can be determined by turning the equipment off and on, the user is encouraged to try to correct the interference by one or more of the following measures:

- Reorient or relocate the receiving antenna.
- Increase the separation between the equipment and receiver.
- Connect the equipment to an outlet on a circuit different from that to which the receiver is connected.
- Consult a Sony dealer or an experienced radio/TV technician for help.

The supplied interface cable must be used with the equipment in order to comply with the limits for a digital device pursuant to Subpart B of Part 15 of FCC Rules.

Notes on use

Note on Cassette Memory

Your camcorder is based on the DV format. You can use only mini DV cassettes in your camcorder. Use of mini DV cassettes with Cassette Memory is recommended as you can use Title search (p. 60), Date search (p. 61), [**C/II**] TITLE (p. 80), [**C/II**] TAPE TITLE (p. 82).

Cassettes with Cassette Memory are marked with **C/II**.

Note on the type of "Memory Stick" you can use in your camcorder

You can use only a "Memory Stick Duo," which is about half the size of a standard "Memory Stick," in your camcorder (p. 126).

The **MEMORY STICK DUO** mark is indicated on the "Memory Stick Duo."

Notes on recording

- Before starting to record, test the recording function to make sure the picture and sound are recorded without any problems.

→ *continued*

- Compensation for the contents of recordings cannot be provided, even if recording or playback is not possible due to a malfunction of the camcorder, storage media, etc.
- TV color systems differ depending on the countries/regions. To view your recordings on a TV, you need an NTSC system-based TV.
- Television programs, films, video tapes, and other materials may be copyrighted. Unauthorized recording of such materials may be contrary to the copyright laws.

Notes on the LCD panel, viewfinder, and lens

- The LCD screen and the viewfinder are manufactured using extremely high-precision technology, so over 99.99% of the pixels are operational for effective use. However, there may be some tiny black points and/or bright points (white, red, blue, or green in color) that appear constantly on the LCD screen and the viewfinder. These points are normal results of the manufacturing process and do not affect the recording in any way.
- Exposing the LCD screen, the viewfinder, or the lens to direct sunlight for long periods of time may cause malfunctions. Be careful when placing the camera near a window or outdoors.
- Do not aim at the sun. Doing so might cause your camcorder to malfunction. Take pictures of the sun only in low light conditions, such as at dusk.

Note on connecting other device

Before connecting your camcorder to other device such as a VCR or a computer with a USB or i.LINK cable, be sure to insert the connector plug in the proper direction. If you insert the connector plug forcibly in the wrong direction, the terminal may be damaged, or this may cause a malfunction of your camcorder.

Notes on using this manual

- The images of the LCD screen and the viewfinder used on this manual are captured using a digital still camera, and thus may appear different from what you see.
- The illustrations used on this manual are based on the model DCR-HC40.

Notes on using the camcorder

- Hold your camcorder correctly.

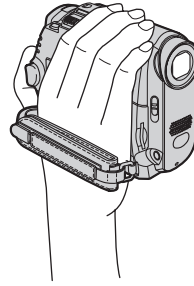

- Fasten the Strap Belt as shown in the following illustration.

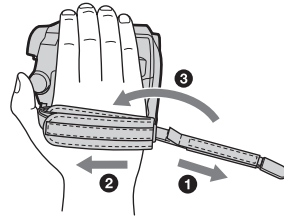

- The Strap Belt can also be used as a wrist strap (p. 140).

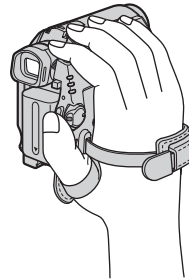

- When you are using the touch panel, place your hand on the back side of the LCD panel to support it. Then, touch the buttons displayed on the screen.

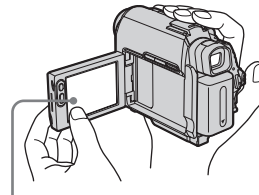

Touch the button on the LCD screen.

- You can change the language to be used for screen display on your camcorder (p. 25).

- Be careful not to press buttons on the LCD frame accidentally when you open or close the LCD panel, or when you adjust the angle of the LCD panel.
- Do not hold the camcorder by the following parts.

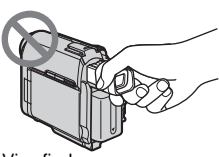

Viewfinder

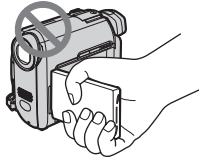

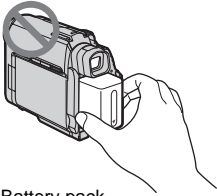

LCD panel



Battery pack

Table of Contents

 : Features available for tape only.
 : Features available for “Memory Stick Duo” only.

Read this first	2
-----------------------	---



Quick Start Guide



Recording movies	10
Recording still images	12
Recording/Playing back with ease	14

Getting started



Step 1: Checking supplied items	15
Step 2: Charging the battery pack	16
Using an outside power source	19
Step 3: Turning the power on	19
Step 4: Adjusting the LCD panel and viewfinder	20
Adjusting the LCD panel	20
Adjusting the viewfinder	21
Step 5: Setting the date and time	22
Step 6: Inserting the recording media	23
Inserting a cassette tape	23
Inserting a “Memory Stick Duo”	24
Step 7: Setting the screen language	25

Recording

Recording movies	26
Recording for a longer time	28
Using zoom	29
Recording in mirror mode	29
Using the self-timer	30
Recording still images  – Memory photo recording	31
Selecting image quality or size	32
Using the self-timer	33
Recording a still image on a “Memory Stick Duo” while recording movies on a tape	34
Recording with ease – Easy Handycam	34
Recording a movie 	34
Recording a still image 	35
Making full use of Easy Handycam operation	36

Adjusting the exposure.....	37
Adjusting the exposure for backlit subjects	37
Fixing the exposure for the selected subject – Flexible spot meter	37
Adjusting the exposure manually	38
Recording in dark places – NightShot plus, etc.	39
Adjusting the focus.....	40
Adjusting the focus for an off-center subject – SPOT FOCUS	40
Adjusting the focus manually	41
Recording a picture using various effects	42
Fading in and out of a scene  – FADER	42
Using special effects  – Digital effect	43
Overlaying still images on movies on a tape – MEMORY MIX	45
Searching for the starting point 	47
Searching for the last scene of the most recent recording – END SEARCH	47
Searching manually – EDIT SEARCH	47
Reviewing the most recently recorded scenes – Rec review	48









Playback

Viewing movies recorded on a tape 	49
Playing back in various modes	50
Viewing recordings with added effects – Digital effect	51
Viewing recordings on a “Memory Stick Duo” 	52
Playing back in various modes from a “Memory Stick Duo”	53
Playing back with ease – Easy Handycam	54
Making full use of Easy Handycam operation	55
Various playback functions	56
Magnifying pictures – Tape playback zoom/Memory playback zoom	56
Displaying the screen indicators	57
Displaying the date/time and camera settings data – Data code	57
Playing the picture on a TV	59
Locating a scene on a tape for playback 	60
Searching quickly for a desired scene – Zero set memory	60
Searching for a scene using Cassette Memory – Title search	60
Searching for a scene by date of recording – Date search	61





→ continued

Advanced operations

Using the Menu

Selecting menu items	62
Using the  (CAMERA SET) menu	
– PROGRAM AE/WHITE BAL./16:9 WIDE, etc.	64
Using the  (MEMORY SET) menu	
– BURST/QUALITY/IMAGE SIZE/ ALL ERASE/NEW FOLDER, etc.	70
Using the  (PICT. APPLI.) menu	
– PICT. EFFECT/SLIDE SHOW/ FRAME REC/INTERVAL REC/INT. REC-STL, etc.	74
Using the  (EDIT/PLAY) menu	
–  TITLE/  TAPE TITLE, etc.	79
Using the  (STANDARD SET) menu	
–  REC MODE/MULTI-SOUND/ AUDIO MIX/USB-CAMERA, etc.	83
Using the  (TIME/LANGU.) menu	
– CLOCK SET/WORLD TIME, etc.	88
Customizing Personal Menu	89

Dubbing/Editing

Connecting to a VCR or TV	92
Dubbing to another tape 	93
Recording pictures from a VCR or TV	94
Dubbing pictures from a tape to a “Memory Stick Duo”	95
Dubbing still images from a “Memory Stick Duo” to a tape	96
Dubbing selected scenes from a tape – Digital program editing	97
Dubbing sound to a recorded tape 	104
Deleting recorded pictures 	106
Marking recorded images with specific information  – Image protection/ Print mark	107
Printing recorded images (PictBridge compliant printer) 	109

Troubleshooting

Troubleshooting	112
Warning indicators and messages ...	120

Additional Information

Using your camcorder abroad	124
Usable cassette tapes	125
About the “Memory Stick”	126
About the “InfoLITHIUM” battery pack	129
About i.LINK	130
Maintenance and precautions	131
Specification	134

Quick Reference

Identifying parts and controls	137
Index	144

Refer also to other operating instructions
supplied with your camcorder:

- Editing images with your computer
→Computer Applications Guide



Quick Start Guide

Recording movies

1 Attach the charged battery pack to the camcorder.

To charge the battery, see page 16.

Slide the battery pack in the direction of the arrow until it clicks.

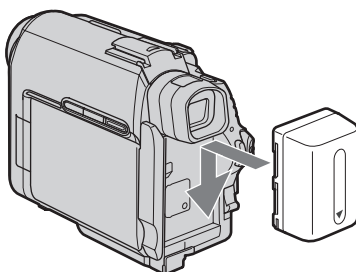

2 Insert a cassette into the camcorder.

- 1 Slide the **OPEN/EJECT** lever in the direction of the arrow to open the lid.

The cassette compartment comes out automatically.

- 2 Insert the cassette with its window-side facing up, then push the center of the back of the cassette.

- 3 Press **PUSH**.

Close the cassette lid after the cassette compartment slides back in by itself.

OPEN/EJECT lever

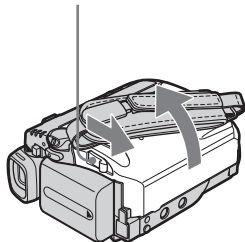

Window-side

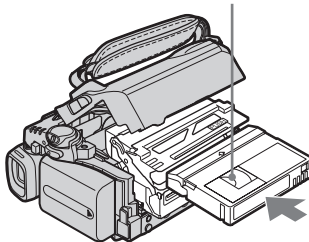

PUSH

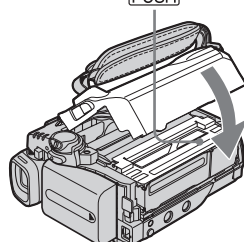

3 Start recording while checking the subject on the LCD screen.

The date and time is not set up in the default setting. To set the date and time, see page 22.

- ❶ Set the **LENS COVER** switch to **OPEN**.
- ❷ Open the **LCD panel**.
- ❸ While pressing the **green button**, slide the **POWER** switch down to light up the **CAMERA-TAPE** lamp.
The power turns on.
- ❹ Press **REC START/STOP**.

Recording starts. To change to standby mode, press **REC START/STOP** again.
You can also use **REC START/STOP** of the **LCD panel**.

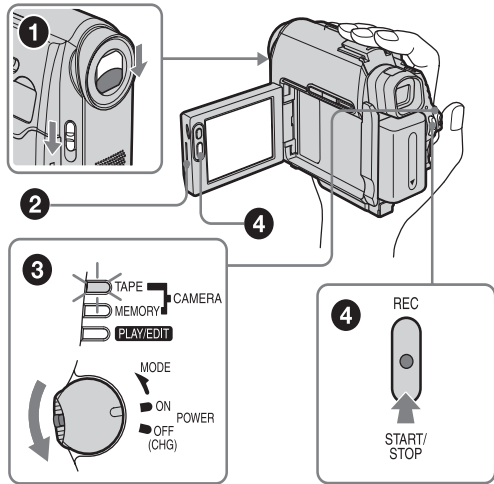

4 View the recorded picture on the LCD screen.

- ❶ Slide the **POWER** switch repeatedly until the **PLAY/EDIT** lamp lights up.
- ❷ Touch **⏮** (rewind).
- ❸ Touch **▶** (play) to start the playback.
To stop, press **■**.

To turn off the power, slide the **POWER** switch up to **OFF (CHG)**.

Set the **LENS COVER** switch to **CLOSE**.

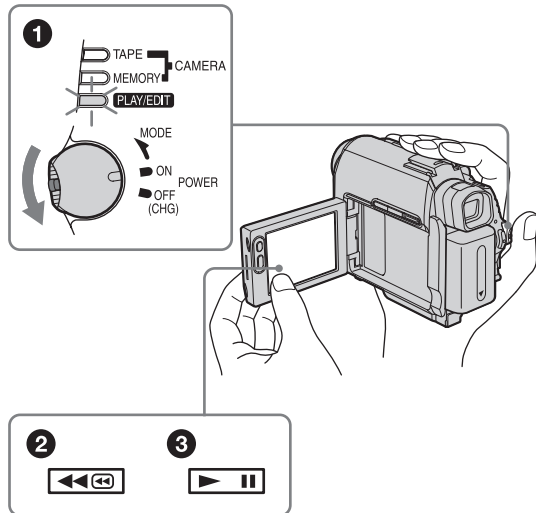

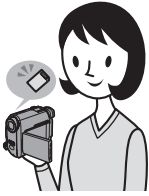

Recording still images

1 Attach the charged battery pack to the camcorder.

To charge the battery, see page 16.

Slide the battery pack in the direction of the arrow until it clicks.

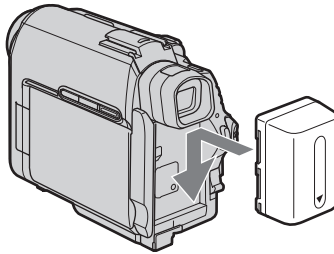

2 Insert a “Memory Stick Duo” into the camcorder.

Insert it so that the ◀ mark is at the bottom left corner. Push in until it clicks.

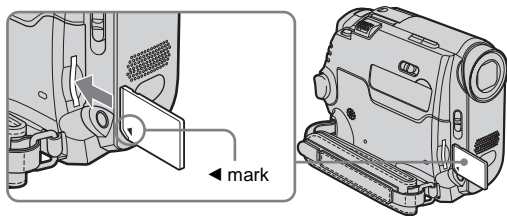

3 Start recording while checking the subject on the LCD screen.

The date and time is not set up in the default setting. To set the date and time, see page 22.

- 1 Set the **LENS COVER** switch to **OPEN**.

- 2 Open the **LCD** panel.

- 3 While pressing the **green button**, slide the **POWER** switch repeatedly until the **CAMERA-MEMORY** lamp lights up.

The power turns on.

- 4 Press **PHOTO** lightly.

A short beep sound is heard when the focus is adjusted.

- 5 Press **PHOTO** fully.

A shutter sound is heard and the still image is recorded.

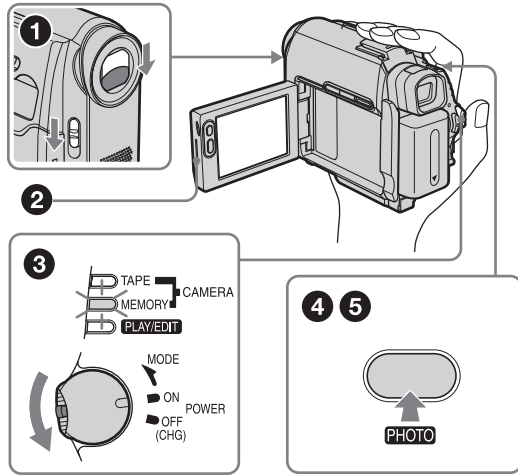

4 View the recorded picture on the LCD screen.

- 1 Slide the **POWER** switch repeatedly until the **PLAY/EDIT** lamp lights up.

- 2 Touch **[PB]**.

The most recently recorded image is displayed.

- 3 Touch **[+]** (next) or **[-]** (previous) to view images in sequence.

To turn off the power, slide the **POWER** switch up to **OFF (CHG)**.

Set the **LENS COVER** switch to **CLOSE**.

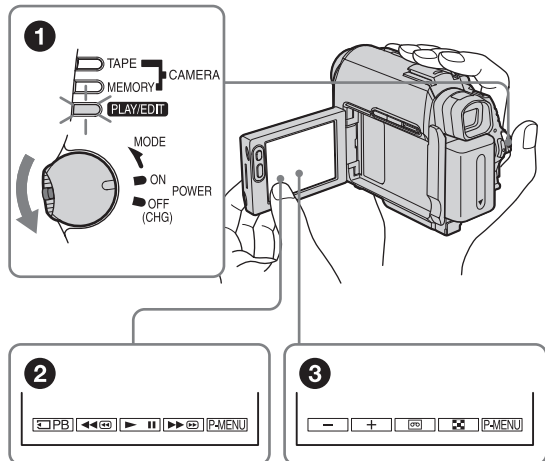



Recording/Playing back with ease

By switching to Easy Handycam operation, recording/playback operation becomes even easier. Easy Handycam operation allows easy recording/playback for even first time users by providing only the basic functions for recording/playback.

Press EASY when recording/ playing back.

EASY lights up in blue (1) and screen font size increases (2) during Easy Handycam operation.

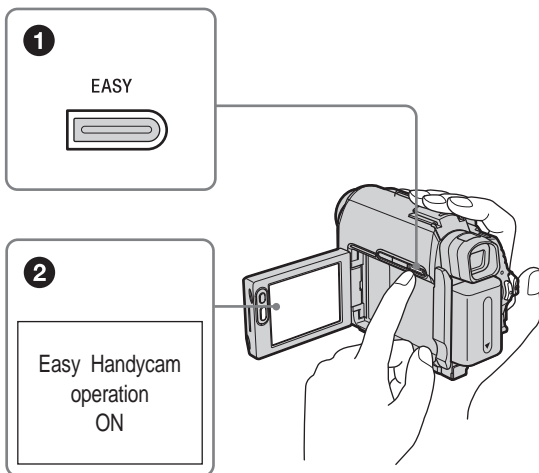

For details, see instructions for each operation.
See page 34 for recording, page 54 for playback.

Step 1: Checking supplied items

Make sure you have following items supplied with your camcorder.

The number in parentheses indicates the number of that item supplied.

“Memory Stick Duo” 8MB (1)

You can use only a “Memory Stick Duo,” which is about half the size of a standard “Memory Stick,” in your camcorder. See page 126 for details.

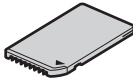

Memory Stick Duo adaptor (1)

If you attach a Memory Stick Duo adaptor to a “Memory Stick Duo,” you can use a “Memory Stick Duo” with any of the devices compatible with a standard “Memory Stick.”

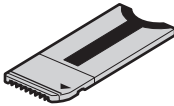

AC Adaptor (1)

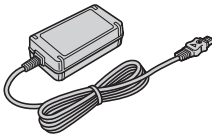

Power cord (1)



Wireless Remote Commander (1)

A button-type lithium battery is already installed.



A/V connecting cable (1)

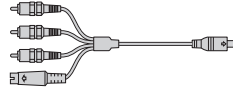

USB cable (1)



Rechargeable battery pack NP-FP50 (1)

CD-ROM “SPVD-012 USB Driver” (1)

Cleaning cloth (1)

Shoe cover (1)

Attached to the camcorder.

Camera Operations Guide (This manual) (1)

Computer Applications Guide (1)

Step 2: Charging the battery pack

You can charge the battery by attaching the “InfoLITHIUM” battery pack (P series) to your camcorder.

Notes

- You cannot use batteries other than the “InfoLITHIUM” battery pack (P series) (p. 129).
- Do not short-circuit the DC plug of the AC Adaptor or battery terminals with any metallic objects. This may cause a malfunction.
- Use a nearby wall outlet when using the AC Adaptor. Disconnect the AC Adaptor from the wall outlet immediately if any malfunction occurs.

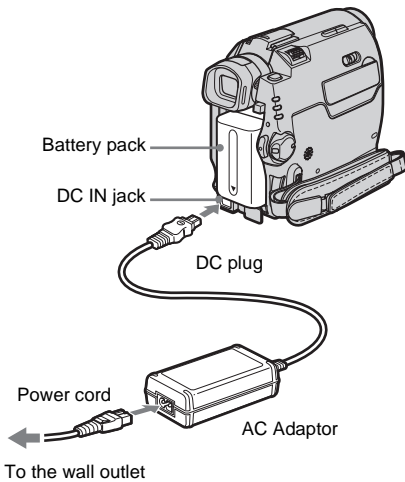

- 1 Attach the battery pack by sliding it in the direction of the arrow until it clicks.

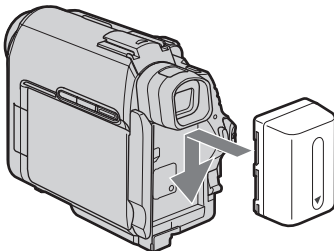

- 2 With the ▲ mark on the DC plug facing down, connect the AC Adaptor to the DC IN jack on your camcorder.

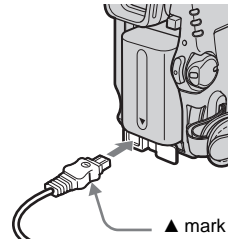

- 3 Connect the power cord to the AC Adaptor.

- 4 Connect the power cord to the wall outlet.

- 5 Slide the POWER switch up to OFF (CHG).

The CHG (charge) lamp lights up and charging starts.

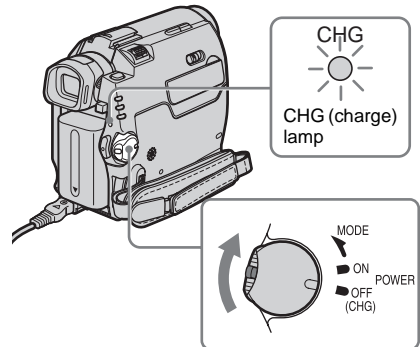

After charging the battery

The CHG (charge) lamp turns off when the battery is fully charged. Disconnect the AC Adaptor from the DC IN jack.

To remove the battery pack

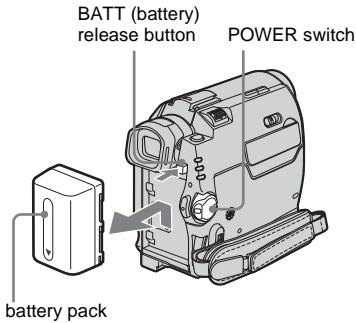

- 1 Set the **POWER** switch to **OFF (CHG)**.
- 2 Slide the battery pack out in the direction of the arrow while pressing the **BATT (battery)** release button down.

Note

- If you do not use the battery pack for a long time, use up the battery pack completely before storing it. See page 129 about storage of the battery pack.

To check the remaining battery – Battery Info

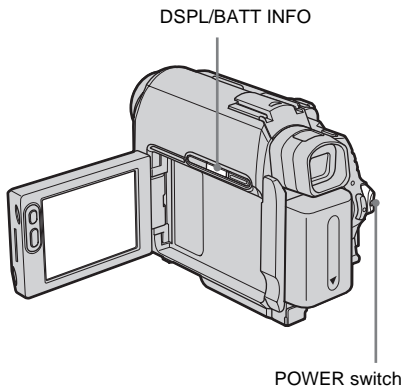

You can check the battery's current charge level and its current remaining recording time both during charging or when the power is turned off.

- 1 Set the **POWER** switch to **OFF (CHG)**.
- 2 Open the **LCD** panel.
- 3 Press **DSPL/BATT INFO**.
The battery information appears for about 7 seconds.
Keep the button pressed to view it for about 20 seconds.

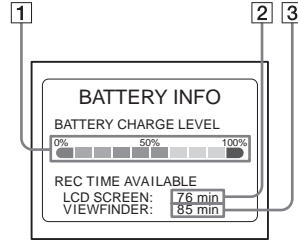

- 1 **Battery charge level:** Displays approximate remaining amount of power left in the battery pack.
- 2 **Approximate possible recording time using the LCD panel.**
- 3 **Approximate possible recording time using the viewfinder.**

Charging time

Approximate number of minutes required when you fully charge a fully discharged battery pack at 25°C (77°F). (10 – 30°C (50 – 86°F) recommended.)

Battery pack	
NP-FP50 (supplied)	125
NP-FP70	155
NP-FP90	220

→ continued

Recording time when recording with the LCD screen on

Approximate number of minutes available when you use a fully charged battery pack at 25°C (77°F).

With LCD BACKLIGHT set to ON

For DCR-HC40:

Battery pack	Continuous recording time	Typical* recording time
NP-FP50 (supplied)	85	45
NP-FP70	180	95
NP-FP90	320	175

For DCR-HC30:

Battery pack	Continuous recording time	Typical* recording time
NP-FP50 (supplied)	105	55
NP-FP70	225	120
NP-FP90	400	220

With LCD BACKLIGHT set to OFF

For DCR-HC40:

Battery pack	Continuous recording time	Typical* recording time
NP-FP50 (supplied)	95	50
NP-FP70	200	110
NP-FP90	355	195

For DCR-HC30:

Battery pack	Continuous recording time	Typical* recording time
NP-FP50 (supplied)	120	65
NP-FP70	255	140
NP-FP90	455	250

Recording time when recording with the viewfinder

Approximate number of minutes available when you use a fully charged battery pack at 25°C (77°F).

For DCR-HC40:

Battery pack	Continuous recording time	Typical* recording time
NP-FP50 (supplied)	95	50
NP-FP70	200	110
NP-FP90	355	195

For DCR-HC30:

Battery pack	Continuous recording time	Typical* recording time
NP-FP50 (supplied)	120	65
NP-FP70	255	140
NP-FP90	455	250

* Approximate number of minutes when recording while you repeatedly record, start/stop, slide the POWER switch to change the power mode, and zoom. The actual battery life may be shorter.

Playing time

Approximate number of minutes available when you use a fully charged battery pack at 25°C (77°F).

For DCR-HC40:

Battery pack	LCD panel opened*	LCD panel closed
NP-FP50 (supplied)	105	120
NP-FP70	225	255
NP-FP90	400	455

For DCR-HC30:

Battery pack	LCD panel opened*	LCD panel closed
NP-FP50 (supplied)	120	140
NP-FP70	255	295
NP-FP90	455	525

* With LCD BACKLIGHT set to ON.

Notes

- The power will not be supplied from the battery pack when the AC Adaptor is connected to the DC IN jack of your camcorder, even if its power cord is disconnected from the wall outlet.
- The recording and playback time will be shorter when you use your camcorder in low temperature.
- The CHG (charge) lamp flashes during charging, or the battery information will not be correctly displayed in following conditions.
 - The battery pack is not attached correctly.
 - The battery pack is damaged.
 - The battery pack is fully discharged. (For Battery information only)

Using an outside power source

You can use the AC Adaptor as the power source when you do not want the battery to run out. While you are using the AC Adaptor, the battery pack will not lose its charge even when it is attached to your camcorder.

PRECAUTION

Even if your camcorder is turned off, AC power (house current) is still supplied to it while connected to the wall outlet via the AC Adaptor.

Connect your camcorder as shown in “Charging the battery pack” (p. 16).

Step 3: Turning the power on

You need to slide the POWER switch repeatedly to select the desired power mode to record or play.

When using this camcorder for the first time, the [CLOCK SET] screen appears (p. 22).

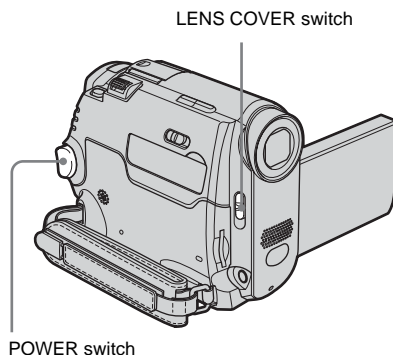

1 Set the LENS COVER switch to OPEN.

2 While pressing the green button, slide the POWER switch down.

The power turns on.

To enter the recording or playing mode, slide the switch repeatedly until the respective lamp for the desired power mode lights up.

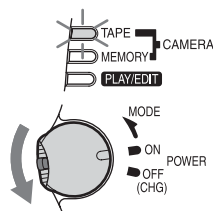

- CAMERA-TAPE mode: To record on a tape.
- CAMERA-MEMORY mode: To record on a “Memory Stick Duo.”
- PLAY/EDIT mode: To play or edit pictures on a tape or “Memory Stick Duo.”

→ continued

To turn off the power

Slide the POWER switch up to OFF (CHG).
Set the LENS COVER switch to CLOSE.

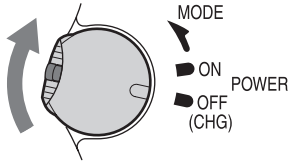

Step 4: Adjusting the LCD panel and viewfinder

Adjusting the LCD panel

You can adjust the angle and brightness of the LCD panel to meet various recording situations.

Even when there are obstructions between you and the subject, you can check the subject on the LCD screen during recording by adjusting the angle of the LCD panel.

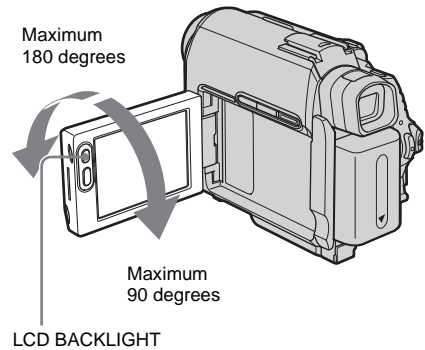



Open the LCD panel 90 degrees to the camcorder, then rotate it to the desired position.



To adjust the brightness of the LCD screen

1 Touch [P-MENU].



2 Touch [LCD BRIGHT].

If the item is not displayed on the screen, touch  / . If you cannot find it, touch

[MENU],  (STANDARD SET) menu, then touch [LCD/VF SET] (p. 84).

- 3 Adjust the item with  / , then touch .**

Tips

- If you rotate the LCD panel 180 degrees to the lens side, you can close the LCD panel with the LCD screen facing out.
- If you are using the battery pack for power source, you can adjust the brightness by selecting [LCD BL LEVEL] from the [LCD/VF SET] on the  (STANDARD SET) menu (p. 84).
- When you use your camcorder in bright conditions, press LCD BACKLIGHT to switch off the LCD screen backlight ( appears on the screen.). This setting saves battery power.
- Even if you adjust the LCD screen backlight, the recorded picture will not be affected.
- You can turn off the operation confirmation beep by setting [BEEP] in the  (STANDARD SET) menu to [OFF] (p. 87).

Adjusting the viewfinder

You can view images using the viewfinder when you close the LCD panel. Use the viewfinder when the battery is running out, or when the screen is hard to see.

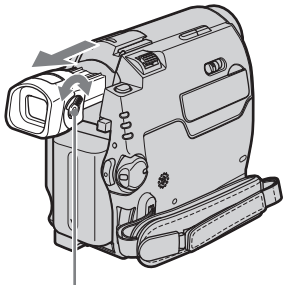







Viewfinder lens adjustment lever

-
- 1 Extend the viewfinder.**
 - 2 Adjust the viewfinder lens adjustment lever until the picture is clear.**
-

To use the viewfinder during operation

When you are recording on a tape or a “Memory Stick Duo,” you can adjust the exposure (p. 37) and fader (p. 42) while checking the image on the viewfinder. Have the LCD panel rotated 180 degrees and closed with the screen facing out.

- 1 Set the power mode to CAMERA-TAPE or CAMERA-MEMORY (p. 19).**
- 2 Extend the viewfinder, and close the LCD panel with the screen facing out.**
 appears on the screen.
- 3 Touch .**
[Set LCD off?] appears on the screen.
- 4 Touch [YES].**
The LCD screen is turned off.
- 5 Touch the LCD screen while checking the display in the viewfinder.**
[EXPOSURE], etc. are displayed.
- 6 Touch the button you want to set.**
 - [EXPOSURE]: Adjust with  /  and touch .
 - [FADER]: Touch it repeatedly to select a desired effect (only in the CAMERA-TAPE mode).
 - : The LCD screen lights up.
To hide the buttons on the LCD screen, touch .

Tip

- To adjust the brightness of the viewfinder backlight, select  (STANDARD SET) menu, [LCD/VF SET], then [VF B.LIGHT] (when you are using the battery pack, p. 85).

Step 5: Setting the date and time

Set the date and time when using this camcorder for the first time. If you do not set the date and time, the [CLOCK SET] screen appears every time you turn on your camcorder.

Note

- If you do not use your camcorder for about 3 months, the built-in rechargeable button-type battery gets discharged and the date and time settings may be cleared from the memory. In that case, charge the rechargeable button-type battery (p. 134) and then set the date and time again.

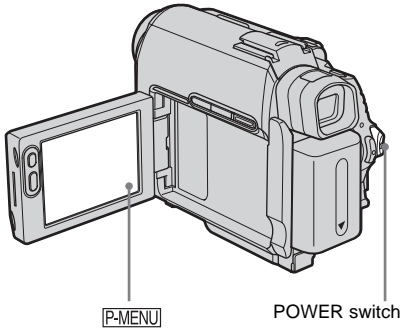

1 Turn on your camcorder (p. 19).

2 Open the LCD panel.

Proceed to step 7 when you set the clock for the first time.

3 Touch [P-MENU].

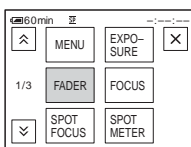

4 Touch [MENU].

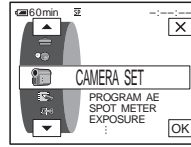

5 Select (TIME/LANGU.) with \uparrow/\downarrow , then touch [OK].

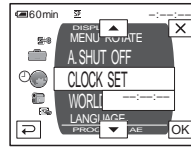

6 Select [CLOCK SET] with \uparrow/\downarrow , then touch [OK].

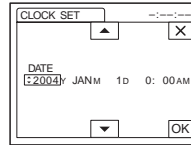

7 Set [Y] (year) with \uparrow/\downarrow , then touch [OK].

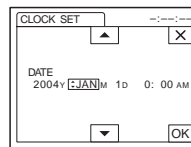

You can set any year up to the year 2079.

8 Set [M] (month), [D] (day), hour and minute in the same way as was done in step 7, then touch [OK].

For midnight, set it to 12:00AM.
For midday, set it to 12:00PM.

Step 6: Inserting the recording media

Inserting a cassette tape

You can use mini DV ^{Mini}DV cassettes only. For details on these cassettes (such as write-protection), see page 125.

Note

- Do not force the cassette into the compartment. This may cause a malfunction of your camcorder.

- 1 Slide the **OPEN/▲EJECT ▼** lever in the direction of the arrow and open the lid.

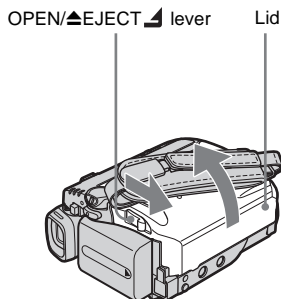

The cassette compartment automatically comes out and opens up.

- 2 Insert a cassette with its window-side facing up.

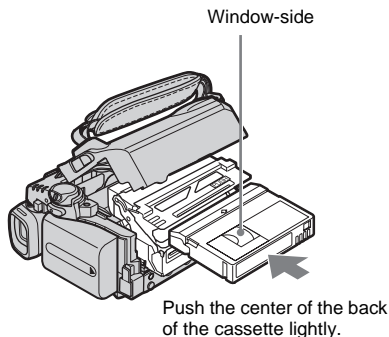

- 3 Press **PUSH**. The cassette compartment automatically slides back in.

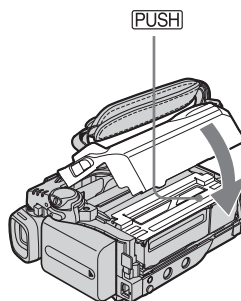

- 4 Close the lid.

To eject the cassette

- 1 Slide the **OPEN/▲EJECT ▼** lever in the direction of the arrow and open the lid. The cassette compartment automatically comes out.
- 2 Take out the cassette, then press **PUSH**. The cassette compartment automatically slides back in.
- 3 Close the lid.

→ continued

Inserting a “Memory Stick Duo”

For details on the “Memory Stick Duo” (such as write-protection), see page 126.

⚡ Note

- You can use only a “Memory Stick Duo,” which is about half the size of a standard “Memory Stick,” in your camcorder (p. 126). Do not try to force any other type of “Memory Stick” into the “Memory Stick Duo” slot.

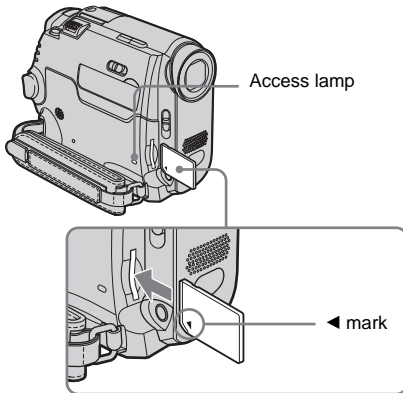

Insert the “Memory Stick Duo” with the ◀ mark at the bottom left corner until it clicks.

To eject a “Memory Stick Duo”

Lightly push the “Memory Stick Duo” in once.

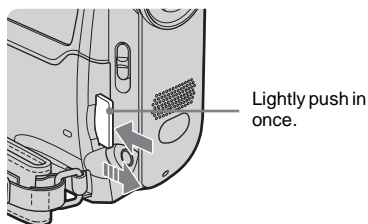

⚡ Notes

- If you force the “Memory Stick Duo” into the “Memory Stick Duo” slot in the wrong direction, the “Memory Stick Duo” slot may be damaged.
- Do not insert anything other than a “Memory Stick Duo” into the “Memory Stick Duo” slot. Doing so may cause a malfunction of your camcorder.
- When the access lamp is lit or flashing, your camcorder is reading/writing data from/to the “Memory Stick Duo.” Do not shake or knock your camcorder, turn the power off, eject the “Memory Stick Duo,” or remove the battery pack. Otherwise, image data may be damaged.

Step 7: Setting the screen language

You can select the language to be used on the LCD screen.

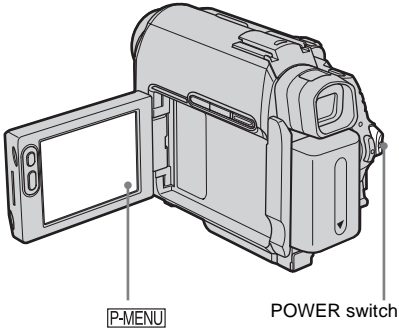

- 5 Select the desired language with / , then touch .

Tip

- Your camcorder offers [ENG [SIMP]] (simplified English) for when you cannot find your native tongue among the options.

- 1 Turn on your camcorder.

- 2 Open the LCD panel.

- 3 Touch .

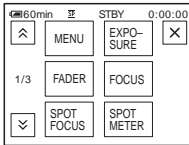

- 4 Touch .

If the item is not displayed on the screen, touch / . If you cannot find it, touch , and select it from the (TIME/LANGU.) menu (p. 88).

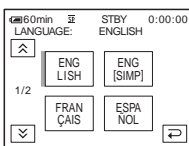

Recording movies

You can record movies on a tape or a “Memory Stick Duo.”

Before recording, follow steps 1 to 7 in “Getting started” (p. 15 to p. 25).

When you are recording on a tape, movies will be recorded along with stereo sound. When you are recording on a “Memory Stick Duo,” the movie will be recorded with monaural sound.

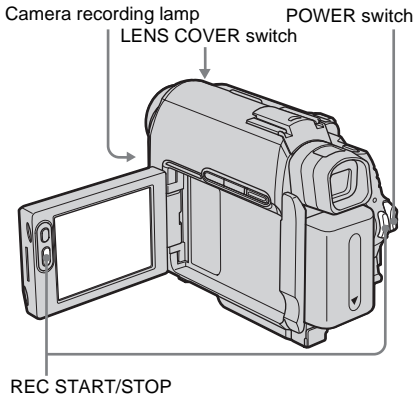

Tip

- Performing Easy Handycam operation, even first time users can record easily. For details, see page 34.

1 Set the LENS COVER switch to OPEN.

2 Open the LCD panel.

3 Select the recording mode.

To record on a tape

Slide the POWER switch until the CAMERA-TAPE lamp lights up, and your camcorder is set to the standby mode.

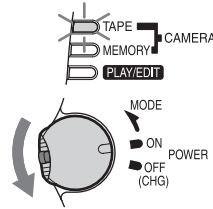

Slide the POWER switch while pressing the green button.

To record on a “Memory Stick Duo” – MPEG MOVIE EX

Slide the POWER switch repeatedly until the CAMERA-MEMORY lamp lights up, and the currently selected recording folder appears on the screen.

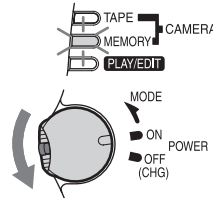

Slide the POWER switch while pressing the green button.

4 Press REC START/STOP.

Recording starts. [REC] appears on the LCD screen and the Camera recording lamp lights up.

Press REC START/STOP again to stop recording.

To check the most recently recorded MPEG movie – Review

Touch . Playback starts automatically.

Touch again to return to standby.

To delete the movie, touch after playback is finished, then [YES].

To cancel deleting, touch [NO].

To turn the power off

- Slide the POWER switch up to the OFF (CHG) position.
- Set the LENS COVER switch to CLOSE.

Indicators displayed during recording on a tape

The indicators will not be recorded on the tape. Date/time and the camera settings data (p. 57) will not be displayed during recording.

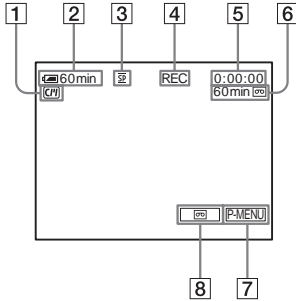

- 1 Indicators for Cassette Memory cassettes**
- 2 Remaining battery**

The indicated time may not be correct depending on the environment of use. When you opened or closed the LCD panel, it takes about 1 minute to display the correct remaining battery time.
- 3 Recording mode (SP or LP)**
- 4 Recording status ([STBY] (standby) or [REC] (recording))**
- 5 Time code or tape counter (hour: minute: second)**
- 6 Recording capacity of the tape (p. 86)**
- 7 Personal Menu button (p. 62)**
- 8 END SEARCH/EDIT SEARCH/Rec review display switch button (p. 47)**

Indicators displayed during recording on a "Memory Stick Duo"

The indicators will not be recorded on the "Memory Stick Duo." Date/time (p. 57) will not be displayed during recording.

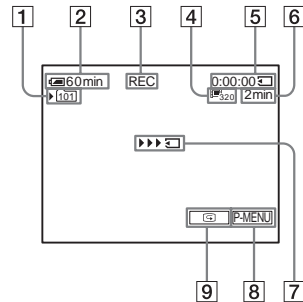

- 1 Recording folder**
- 2 Remaining battery**

The indicated time may not be correct depending on the environment of use. When you opened or closed the LCD panel, it takes about 1 minute to display the correct remaining battery time.
- 3 Recording status ([STBY] (standby) or [REC] (recording))**
- 4 Movie size**
- 5 Recorded time (hour: minute: second)**
- 6 Recording capacity of the "Memory Stick Duo"**
- 7 "Memory Stick Duo" recording start indicator (appears for about 5 seconds)**
- 8 Personal Menu button (p. 62)**
- 9 Review button (p. 26)**

⚡ Notes

- Before changing the battery pack, slide the POWER switch up to OFF (CHG).
- In the default setting, when you do not operate the camcorder for more than about 5 minutes, the power will automatically turn off to prevent battery loss ([A.SHUT OFF], p. 87). To restart recording, slide the POWER switch down to select CAMERA-TAPE or CAMERA-MEMORY, and then press REC START/STOP.
- While recording movies on a "Memory Stick Duo," the only menu items available will be those with short cuts on the Personal Menu. In order to use other menu items, add them to the Personal Menu.

→ continued



- When you are recording on a “Memory Stick Duo” with an external flash (optional) connected to the accessory shoe, turn off the power of the external flash to prevent charging noise being recorded.

Tips

- If you do not use your camcorder for a long time, remove the cassette and store it.
- You can also use REC START/STOP of the LCD panel to record moving pictures. It is useful when you record from a low-angle or record yourself in the mirror mode.
- To press REC START/STOP on LCD frame, support the LCD panel with your hand.
- Recording with LCD screen is recommended when you use the large capacity battery pack (NP-FP70/FP90).
- To ensure smooth transition on a tape from the last recorded scene to the next, note the following.
 - Do not remove the cassette. (The picture will be recorded continuously without a break even when you turn the power off).
 - Do not record pictures in SP mode and LP mode on the same tape.
 - Avoid stopping then recording a movie in the LP mode.
- See “To record for a longer time on a “Memory Stick Duo”” (p. 28) for the approximate length of time it is possible to record on a “Memory Stick Duo” of different capacities.
- The recording time, date, and the camera settings data (for tape only) are recorded automatically on the recording media without being displayed on the screen. You can view this information during playback by selecting [DATA CODE] in the menu setting (p. 57).

Recording for a longer time

To record for a longer time on a tape

In the  (STANDARD SET) menu, select [ REC MODE], then [LP] (p. 83).



In the LP mode, you can record 1.5 times longer than you can when recording in the SP mode. A tape recorded in the LP mode should be played back only on this camcorder.

To record for a longer time on a “Memory Stick Duo”

In the  (MEMORY SET) menu, select [MOVIE SET], [ IMAGE SIZE], then [160 × 112] (p. 71).

The length of time you can record on a “Memory Stick Duo” varies depending on the image size and the recording environment. Refer to the following list for approximate length of time you can record movies on a “Memory Stick Duo” formatted on your camcorder.

Image size and time (hour: minute: second)

	320 × 240  320	160 × 112  160
8MB (supplied)	00:01:20	00:05:20
16MB	00:02:40	00:10:40
32MB	00:05:20	00:21:20
64MB	00:10:40	00:42:40
128MB	00:21:20	01:25:20
256MB (MSX-M256)	00:42:40	02:50:40
512MB (MSX-M512)	01:25:20	05:41:20

Using zoom

When the CAMERA-TAPE mode is selected, you can choose zoom to magnification levels greater than 10 times, and from that point activate the digital zoom ([DIGITAL ZOOM], p. 68). Occasional use of the zoom is effective, but use it sparingly for best results.

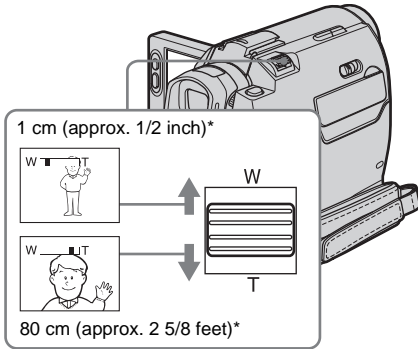

* The minimum distance required between your camcorder and the subject to get a sharp focus in that position of the lever.

Move the power zoom lever slightly for a slower zoom. Move it further for a faster zoom.

To record wider range of view

Move the power zoom lever towards W. The subject appears farther away (Wide angle).

To record closer view

Move the power zoom lever towards T. The subject appears closer (Telephoto).

Recording in mirror mode

You can turn the LCD panel towards the subject so that you and your subject can share the image being recorded. You can also utilize this function when recording yourself, to keep the attention of small children attracted to the camcorder while you record them.

Extend the viewfinder.

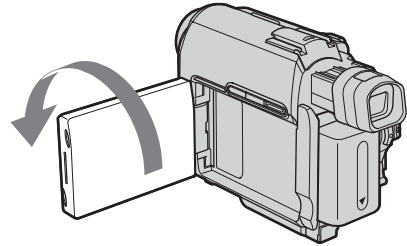

Open the LCD panel 90 degrees to the camcorder, then rotate it 180 degrees towards the subject.

A mirror-image of the subject appears on the LCD screen, but the picture will be normal when recorded.

Using the self-timer

With the self-timer, you can start recording after a delay of about 10 seconds.

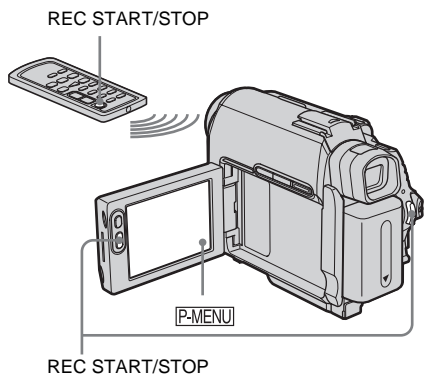

1 Touch **[P-MENU]**.

2 Touch **[SELF-TIMER]**.

If the item is not displayed on the screen, touch \uparrow / \downarrow . If you cannot find it, touch **[MENU]**, and select it from the  (CAMERA SET) menu.

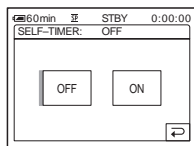

3 Touch **[ON]**, then **[OK]**.

 appears.

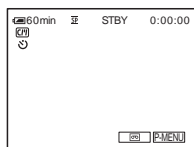

4 Press **REC START/STOP**.

You will hear a beep sound counting down for about 10 seconds (The count down indication begins from 8).

The recording starts.

To stop recording, press **REC START/STOP**.

To cancel the count down

Touch **[RESET]** or press **REC START/STOP**.

To cancel the self-timer

Follow steps 1 and 2, then select **[OFF]** in step 3.

Recording still images

– Memory photo recording

You can record still images on a “Memory Stick Duo.” Before recording, follow steps 1 to 7 in “Getting started” (p. 15 to p. 25).

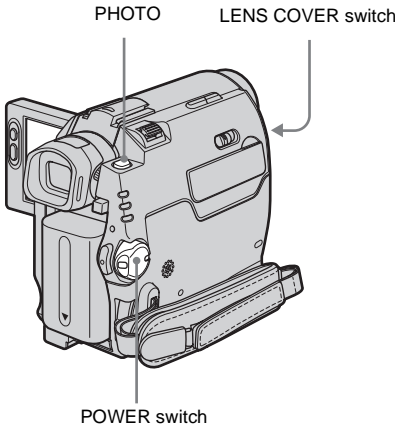

 **Tip**

- Performing Easy Handycam operation, even first time users can record easily. For details, see page 34.

1 Set the LENS COVER switch to OPEN.

2 Open the LCD panel.

3 Slide the POWER switch repeatedly until the CAMERA-MEMORY lamp lights up.

The selected recording folder is displayed.

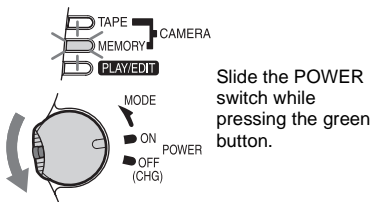

4 Press and hold PHOTO lightly.

You will hear a light beeping sound when the focus and brightness settings are adjusted. Recording does not start at this point.

The indicator stops flashing.

The number of images that can be recorded.*

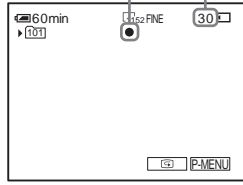



*The number of images that can be recorded varies depending on the image quality setting and the recording environment.

5 Press PHOTO fully.

A shutter sound is heard. When bars of  disappear, the image is recorded on the “Memory Stick Duo.”

To check the most recently recorded image – Review

Touch .

Touch  to return to standby.

To delete the image, touch , then [YES].

To cancel deleting, touch [NO].



To turn the power off

1 Slide the POWER switch up to the OFF (CHG) position.

2 Set the LENS COVER switch to CLOSE.

To record still images continuously – Burst

For DCR-HC40:

Select the  (MEMORY SET) menu, [STILL SET], then  (p. 70).

You can record 3 to 13 images continuously in a time interval of about 0.5 seconds.

→ continued

Indicators displayed during recording

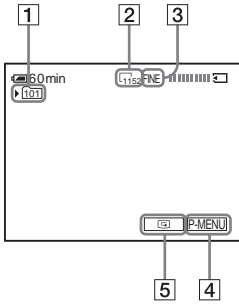

1 Recording folder

2 Image size

For DCR-HC40:

(1152 × 864) or (640 × 480)

3 Quality

FINE ([FINE]) or STD ([STANDARD])

4 Personal Menu button (p. 62)

5 Review button (p. 31)

🔦 Tips

- When you press PHOTO on your Remote Commander, the image displayed on the screen at that timing is recorded.
- The recording time, date, and the camera settings data are recorded automatically on the recording media without being displayed on the screen. You can view this information during playback by selecting [DATA CODE] on the screen (p. 57).
- The recording angle is wider than that of the CAMERA-TAPE mode.

Selecting image quality or size

For DCR-HC40:

Select the (MEMORY SET) menu, [STILL SET], then [QUALITY] or [IMAGE SIZE] (p. 71).

For DCR-HC30:

Select the (MEMORY SET) menu, [STILL SET], then [QUALITY].

The image size is set to [640 × 480].

The number of pictures you can record on a “Memory Stick Duo” varies depending on the quality/size of the image and the recording environment.

Refer to the following list for the approximate number of pictures that can be recorded on a “Memory Stick Duo” formatted on your camcorder.

When the image quality is [FINE] (number of images)

The image size of 1152 × 864 for DCR-HC40 is 500kB, that of 640 × 480 is 150kB.

	1152 × 864*	640 × 480
8MB (supplied)	15	50
16MB	30	96
32MB	61	190
64MB	120	390
128MB	245	780
256MB (MSX-M256)	445	1400
512MB (MSX-M512)	900	2850

* The image size of 1152 × 864 is available for DCR-HC40 only.

When the image quality is [STANDARD] (number of images)

The image size of 1152 × 864 for DCR-HC40 is 200kB, that of 640 × 480 is 60kB.

	1152 × 864*	640 × 480
8MB (supplied)	37	120
16MB	74	240
32MB	150	485
64MB	300	980
128MB	600	1970
256MB (MSX-M256)	1000	3550
512MB (MSX-M512)	2050	7200

* The image size of 1152 × 864 is available for DCR-HC40 only.

Using the self-timer

With the self-timer, you can record a still image after a delay of about 10 seconds.

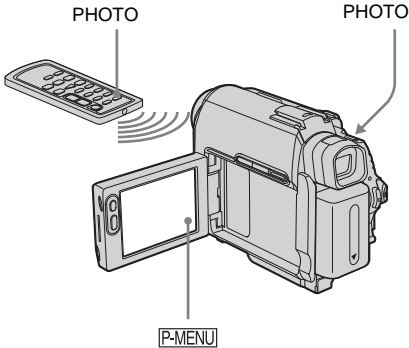

1 Touch **[P-MENU]**.

2 Touch **[SELF-TIMER]**.

If the item is not displayed on the screen, touch **[↑]/[↓]**. If you cannot find it, touch **[MENU]** and select it from the **[CAMERA SET]** menu.

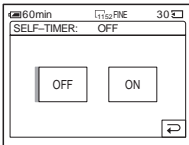

3 Touch **[ON]**, then **[OK]**.

[ON] appears.

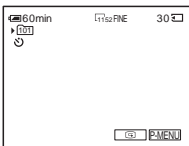

4 Press **PHOTO**.

You will hear a beep sound counting down for about 10 seconds (The count down indication begins from 8).

The image is recorded. When bars of **[|||||]** disappear, the image is recorded on the "Memory Stick Duo."

To cancel the count down

Touch **[RESET]**.

To cancel the self-timer

Follow steps 1 and 2, then select **[OFF]** in step 3.

→ *continued*

Recording a still image on a "Memory Stick Duo" while recording movies on a tape

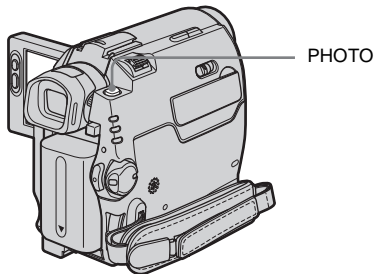

PHOTO

Press PHOTO fully during tape recording.

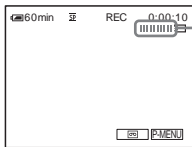

Recording is complete when the scrolling stops.

To record still images in standby mode

Press and hold PHOTO lightly. Check the image and press it fully.

Tip

- For DCR-HC40:
The image size is set to [640 × 480].
If you want to record a still image in a different size, use the Memory photo recording function (p. 31).

Notes

- You cannot record a still image on a "Memory Stick Duo" during the following operations:
 - [16:9 WIDE] mode
 - Memory overlap
 - MEMORY MIX function
 - [INTERVAL REC] (interval recording)
- Titles are not recorded on a "Memory Stick Duo."

Recording with ease

– Easy Handycam

With this Easy Handycam operation, most of the camera settings are set to automatic mode, only basic functions become available, and screen font size increases for easy viewing. Even first time users can enjoy easy recording. Before recording, follow steps 1 to 7 in "Getting started" (p. 15 to p. 25)

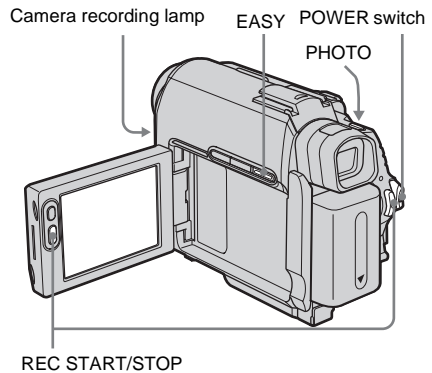

Recording a movie

During Easy Handycam operation, you can record movies on a tape only. To record movies on a "Memory Stick Duo," see page 26 (MPEG MOVIE EX).

1 Set the LENS COVER switch to OPEN.

2 Open the LCD panel.

3 Slide the POWER switch until the CAMERA-TAPE lamp lights up.

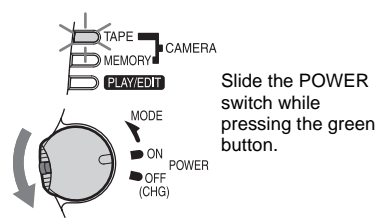

4 Press EASY.
The EASY lights up in blue.



5 Press REC START/STOP.
Recording starts. [REC] appears on the LCD screen and the Camera recording lamp lights up. Press REC START/STOP again to stop recording.

To turn the power off

- 1 Slide the POWER switch up to the OFF (CHG) position.**
- 2 Set the LENS COVER switch to CLOSE.**

To cancel Easy Handycam operation
Press EASY again.

- Notes**
- You cannot turn Easy Handycam operation on or off during:
 - Recording
 - USB Streaming
 - During Easy Handycam operation, the following buttons are not available.
 - LCD BACKLIGHT(p. 20)
 - BACK LIGHT(p. 37)
 - During Easy Handycam operation, the settings of the functions that are not displayed on the screen return to their defaults. Previously made settings are restored when you cancel Easy Handycam operation.

Recording a still image

1 Set the LENS COVER switch to OPEN.

2 Open the LCD panel.

3 Slide the POWER switch repeatedly until the CAMERA-MEMORY lamp lights up.

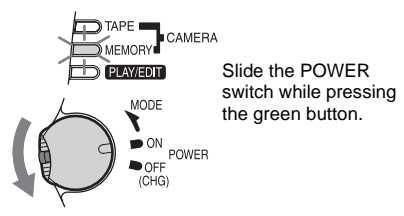

4 Press EASY.
The EASY lights up in blue.

5 Press and hold PHOTO lightly.
You will hear a light beeping sound when the focus and brightness settings are adjusted. Recording does not start at this point.

→ continued

6 Press PHOTO fully.

A shutter sound is heard. When bars of  disappear, the image is recorded on the “Memory Stick Duo.”

To turn the power off

- 1 Slide the POWER switch up to the OFF (CHG) position.
- 2 Set the LENS COVER switch to CLOSE.

To cancel Easy Handycam operation

Press EASY again.

Notes

- You cannot turn Easy Handycam operation on or off during recording.
- During Easy Handycam operation, the following buttons are not available.
 - LCD BACKLIGHT(p. 20)
 - BACK LIGHT(p. 37)
- During Easy Handycam operation, the settings of the functions that are not displayed on the screen return to their defaults. Previously made settings are restored when you cancel the Easy Handycam operation.

Making full use of Easy Handycam operation

1 Touch [MENU].

The available menu items are displayed on the screen.



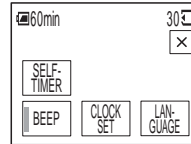

Example: In the CAMERA-MEMORY mode





2 Touch the desired item.

3 Select the desired setting.

For [CLOCK SET]

- 1 Set [Y] (year) with /, then touch .
- 2 Set [M] (month), [D] (day), hour and minutes in the same way as [Y] (year), then touch .



For [LANGUAGE]

Select the desired language with /, then touch .

For [BEEP]

See page 87.

For [SELF-TIMER] (in the CAMERA-MEMORY mode only)

Touch [ON], then . Touch .

Press PHOTO fully.
You will hear a beep sound counting down for about 10 seconds. When the bars of  disappear, the image is recorded on the “Memory Stick Duo.”

Adjusting the exposure

The exposure is adjusted automatically in the default setting.

Adjusting the exposure for backlit subjects

When your subject has its back to the sun or other light, you can adjust the exposure to prevent the subject from becoming shadowed.

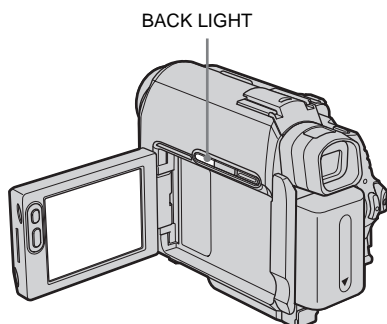

Press BACK LIGHT during recording or in the standby mode.

 appears.

To cancel the back light function, press BACK LIGHT again.

Note



- The back light function is canceled when you set [EXPOSURE] to [MANUAL] (p. 38) or select [SPOT METER] (p. 37).

Fixing the exposure for the selected subject – Flexible spot meter

You can adjust and fix the exposure to the subject, so that it is recorded in suitable brightness even when there is strong contrast between the subject and the background (such as subjects in the limelight on stage).

1 Touch [P-MENU] during recording or in the standby mode.

2 Touch [SPOT METER].

If the item is not displayed on the screen, touch /. If you cannot find it, touch [MENU], and select it from the  (CAMERA SET) menu.

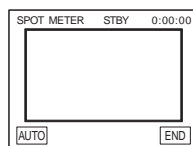

3 Touch the point you want to adjust and fix the exposure on the screen.

[SPOT METER] flashes while the camera is adjusting the exposure for the selected point.

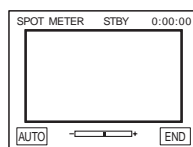

4 Touch [END].

To return the setting to automatic exposure

Follow steps 1 and 2, then select [AUTO] in step 3. Or set [EXPOSURE] to [AUTO] (p. 38).

→ continued

Notes

- You cannot use the Flexible spot meter together with:
 - NightShot plus function
 - Super NightShot plus function
 - Color Slow Shutter function
- If you set [PROGRAM AE], [SPOT METER] is automatically set to [AUTO].

Tip

- If you set [SPOT METER], [EXPOSURE] is automatically set to [MANUAL].

Adjusting the exposure manually

You can fix the brightness of a picture at the best exposure. When recording indoors on a clear day, for instance, you can avoid backlight shadows on people next to the window by manually fixing the exposure to that of the wall side of the room.

1 Touch [P-MENU] during recording or in the standby mode.

2 Touch [EXPOSURE].

If the item is not displayed on the screen, touch \uparrow/\downarrow . If you cannot find it, touch [MENU], and select it from the  (CAMERA SET) menu.

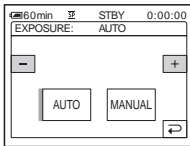

3 Touch [MANUAL].

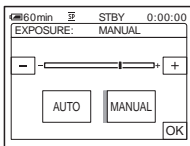

4 Adjust the exposure by touching \square (dim)/ \square (+) (bright), then touch \square (OK).

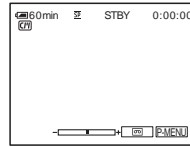

To return the setting to automatic exposure

Follow steps 1 and 2, then select [AUTO] in step 3.

Note

- You cannot use the manual exposure together with:
 - NightShot plus function
 - Super NightShot plus function
 - Color Slow Shutter function

Recording in dark places – NightShot plus, etc.

You can record subjects in dark places (such as when capturing the face of your baby sleeping) with the NightShot plus, Super NightShot plus or Color Slow Shutter function.

The NightShot plus and Super NightShot plus function enable you to record an image brighter and smoother.

The Color Slow Shutter function enables you to record an image more faithful to the original colors.

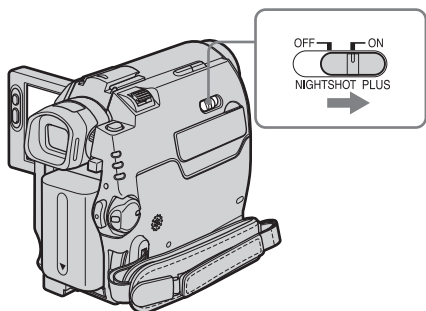

Set the NIGHTSHOT PLUS switch to ON.

and [“NIGHTSHOT PLUS”] appear.
To cancel NightShot plus, set the NIGHTSHOT PLUS switch to OFF.

To record higher sensitivity pictures on the tape – Super NightShot plus

The Super NightShot plus function enables you to use the NightShot plus function more effectively.

The picture will be recorded at a maximum of 16 times the sensitivity of NightShot plus recording.

- 1 Slide the POWER switch to select the CAMERA-TAPE mode.

- 2 Set the NIGHTSHOT PLUS switch to ON.
 and [“NIGHTSHOT PLUS”] appear.
 - 3 Touch .
 - 4 Touch .
- If the item is not displayed on the screen, touch /. If you cannot find it, touch , and select it from the (CAMERA SET) menu.
- 5 Touch , then .
- and [“SUPER NIGHTSHOT PLUS”] appear.
To cancel Super NightShot plus, follow steps 3 and 4, then select [OFF] in step 5. Or, set the NIGHTSHOT PLUS switch to OFF.

To record a clearer picture in color on the tape – Color Slow Shutter

- 1 Slide the POWER switch to select the CAMERA-TAPE mode.
 - 2 Make sure the NIGHTSHOT PLUS switch is set to OFF.
 - 3 Touch .
 - 4 Touch .
- If the item is not displayed on the screen, touch /. If you cannot find it, touch , and select it from the (CAMERA SET) menu.
- 5 Touch , then .
- and [COLOR SLOW SHUTTER] appear.
To cancel Color Slow Shutter, follow steps 3 and 4, then select [OFF] in step 5.

⚙ Notes

- Do not use the NightShot plus/Super NightShot plus function in bright places. This may cause a malfunction.
- The Color Slow Shutter function may not operate correctly in total darkness. When you are recording in a place with no light at all, use the NightShot plus or Super NightShot plus functions.
- You cannot use the Super NightShot plus/Color Slow Shutter function together with:
 - FADER function
 - Digital effect
- You cannot use the Color Slow Shutter function together with:
 - [PROGRAM AE]
 - Manual exposure
 - Flexible spot meter

→ continued

- When using the Super NightShot plus or Color Slow Shutter function, the shutter speed of your camcorder changes depending on the brightness. The motion of the picture may slow down at this time.
- Adjust the focus manually when it is hard to focus automatically.
- Do not cover the infrared port with your fingers or other objects. Remove the conversion lens (optional) if it is attached.
- Depending on the shooting conditions or circumstances, colors may not be reproduced properly.

Tip

- If you record subjects in complete darkness, setting [NS LIGHT] to [ON] in the menu setting is recommended. The maximum shooting distance using the NightShot Light is about 3 m (10 feet). (The default setting is [ON].)
If you record subjects in dark places (such as night scene or in moonlight), set [NS LIGHT] to [OFF] in the menu setting. You can make image color deeper (p. 67).

Adjusting the focus



The focus is adjusted automatically in the default setting.

Adjusting the focus for an off-center subject – SPOT FOCUS

You can select and adjust the focal point to aim it at a subject not located in the center of the screen.

1 Touch [P-MENU] during recording or in the standby mode.

2 Touch [SPOT FOCUS].

If the item is not displayed on the screen, touch /. If you cannot find it, touch [MENU], and select it from the  (CAMERA SET) menu.

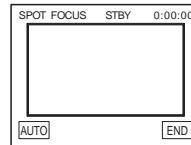

3 Touch the subject for which you want to adjust the focus on the screen.

[SPOT FOCUS] flashes while the camera is adjusting the focus.  appears.

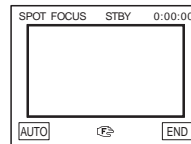

4 Touch [END].

To adjust the focus automatically

Follow steps 1 and 2, then touch [AUTO] in step 3. Or set [FOCUS] to [AUTO] (p. 41).

Note

- You cannot use the SPOT FOCUS function together with [PROGRAM AE].

Tip

- If you set [SPOT FOCUS], [FOCUS] is automatically set to [MANUAL].

Adjusting the focus manually

You can adjust the focus manually according to the recording conditions.

Use this function in the following cases.

- To record a subject behind a window covered with raindrops.
- To record horizontal stripes.
- To record a subject with little contrast between the subject and its background.
- When you want to focus on a subject in the background.



- To record a stationary subject using a tripod.

1 Touch [P-MENU] during recording or in the standby mode.

2 Touch [FOCUS].

If the item is not displayed on the screen, touch / . If you cannot find it, touch MENU, then select it from the (CAMERA SET) menu.

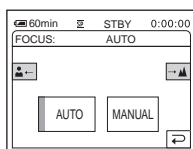

3 Touch [MANUAL].

appears.

4 Touch or to sharpen the focus.

: To focus on close subjects.

: To focus on distant subjects.

changes to when the focus cannot be adjusted any further. changes to when the focus cannot be adjusted any closer.

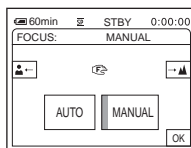

Tips for focusing manually

- It is easier to focus on the subject when you use the zoom function. Move the power zoom lever towards T (telephoto) to adjust the focus, and then, towards W (wide angle) to adjust the zoom for recording.
- When you want to record a close-up image of a subject, move the power zoom lever towards W (wide angle) to fully magnify the image, then adjust the focus.

5 Touch [OK].

To adjust the focus automatically

Follow steps 1 and 2, then select [AUTO] in step 3.

Recording a picture using various effects

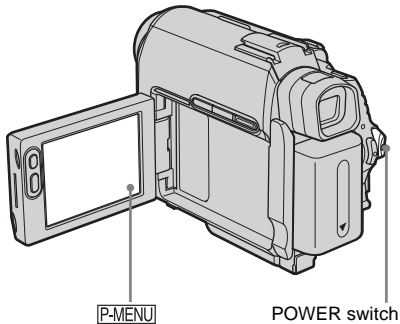

Fading in and out of a scene - FADER

You can add the following effects to currently recording pictures.



[BLACK FADER]



[WHITE FADER]



[MOSAIC FADER]



[MONOTONE]

When fading in, the picture gradually changes from black-and-white to color.
When fading out, the picture gradually changes from color to black-and-white.

[OVERLAP] (fade in only)



[WIPE] (fade in only)



[DOT FADER] (fade in only)

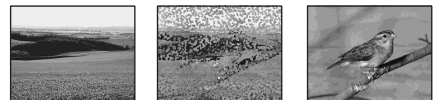

1 Slide the **POWER** switch to select the **CAMERA-TAPE** mode.

2 Touch **[P-MENU]** in the standby mode (to fade in) or during recording (to fade out).

3 Touch **[FADER]**.

If the item is not displayed on the screen, touch / . If you cannot find it, touch], and select it from the (PICT. APPLI.) menu.

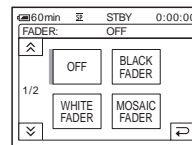

4 Touch the desired effect, then touch **[OK]**.

When you touch [OVERLAP], [WIPE] or [DOT FADER], the image on the tape in your camcorder is stored as a still image. (While storing the image, the screen turns to blue.)

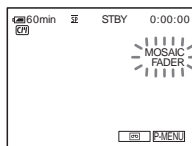

5 Press **REC START/STOP**.

The fader indicator stops flashing and disappears when the fade is complete.

To cancel the operation

Follow steps 2 and 3, then select [OFF] in step 4.

⚡ Note

- You cannot use the FADER function together with:
 - Self-timer
 - Super NightShot plus function
 - Color Slow Shutter function
 - Digital effect
 - [FRAME REC] (Frame recording)
 - [INTERVAL REC] (Interval recording)

Fading in from still image on the “Memory Stick Duo” – Memory overlap

You can fade in from the still image on the “Memory Stick Duo” to the movie currently being recorded on the tape.



- 1 Check that you have a “Memory Stick Duo” with the still image to be superimposed and a tape in your camcorder.
- 2 Slide the **POWER** switch to select the **CAMERA-TAPE** mode.
- 3 Touch **[P-MENU]**.
- 4 Touch **[MENU]**.

- 5 Select **[PICT. APPL.]**, then **[OVERLAP]** by touching **[▲]/[▼]** and **[OK]**.

The recorded image appears on the thumbnail screen.

- 6 Touch **[–] (previous)/[+] (next)** to select the still image to be superimposed.
- 7 Touch **[ON]**, then **[OK]**.
- 8 Touch **[X]**.
- 9 Press **REC START/STOP** to start recording.
[M. OVLAP] stops flashing, and disappears when fading is finished.

Using special effects **[ON]** – Digital effect

You can add digital effects to the recordings.

[STILL]

You can record a movie while superimposing it on a previously recorded still image.



[FLASH] (flash motion)

You can record a movie with a serial-still-image effect (strobe effect).

[LUMI. KEY] (luminance key)

You can replace a brighter area in a previously recorded still image, such as the background of a person or a title written on white paper, with a movie.



[TRAIL]

You can record a picture so that an incidental image like a trail is left.

→ continued

[SLOW SHUTTR] (slow shutter)

You can slow down the shutter speed. This mode is suitable for shooting a subject more clearly in a dark place.

[OLD MOVIE]

You can add an old movie-type atmosphere to pictures. Your camcorder automatically records pictures in the letterbox mode for all screen size, sepia in color, and at a slower shutter speed.

1 Slide the **POWER** switch to select the **CAMERA-TAPE** mode.

2 Touch **[P-MENU]**.

3 Touch **[D. EFFECT]**.

If the item is not displayed on the screen, touch **[↗]**/**[↘]**. If you cannot find it, touch **[MENU]**, and select it from the **[PICT. APPLI.]** menu.

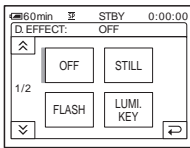

4 Touch the desired effect, then adjust the effect by touching **[−]** (decrease) / **[+]** (increase) and touch **[OK]**.

Adjustment screen example:

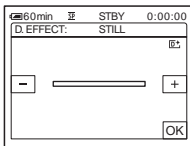

When you touch **[STILL]** or **[LUMI. KEY]**, the image displayed on the screen at that time is saved as a still image.

Effect	Items to adjust
[STILL]	The degree of transparency of the still image you want to superimpose on a movie.
[FLASH]	The interval of frame-by-frame playback.
[LUMI. KEY]	The color scheme of the area in the still image which is to be swapped with a movie.
[TRAIL]	The fade time of the incidental image.
[SLOW SHUTTR]*	Shutter speed (1 is 1/30, 2 is 1/15, 3 is 1/8, 4 is 1/4).
[OLD MOVIE]	No adjustment necessary.

* It is hard to adjust the focus automatically when you choose this effect. Adjust the focus manually using a tripod to steady the camcorder.

5 Touch **[OK]**.
[D+] appears.

To cancel Digital effect

Follow steps 2 and 3, then select **[OFF]** in step 4.

Notes

- You cannot use Digital effect together with:
 - Super NightShot plus function
 - Color Slow Shutter function
 - FADER function
 - Memory overlap
 - MEMORY MIX function
- You cannot use **[SLOW SHUTTR]/[OLD MOVIE]** together with **[PROGRAM AE]** (except **[AUTO]**).
- You cannot use **[OLD MOVIE]** together with:
 - **[16:9 WIDE]** mode
 - Picture effect (**[PICT. EFFECT]**)

Tip

- You can create a picture with color and brightness reversed or a picture that looks like a pastel drawing while recording on a tape. For details, refer to Picture effect (**[PICT. EFFECT]**, p. 74).

Overlaying still images on movies on a tape – MEMORY MIX

You can superimpose a still image you have recorded on a “Memory Stick Duo” over the movie you are currently recording on a tape. You can then record the superimposed pictures on a tape or a “Memory Stick Duo.” (You cannot superimpose a still image on a tape which you have already finished recording.)

[M←CAM LUMI.] (Memory Luminance key)

You can swap the brighter (white) area of a still image into a movie. To use this function, have a still image of an illustration or title handwritten on white paper recorded on a “Memory Stick Duo” beforehand.



[CAM←M CHROMA] (Camera Chroma key)

You can superimpose a movie on top of a still image, such as an image which can be used as background. Shoot the movie with the subject against a blue background. Only the blue area of the movie will be swapped with the still image.

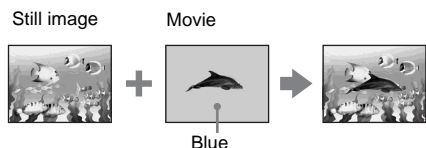

[M←CAM CHROMA] (Memory Chroma key)

You can have the movie swap into the blue area of a still image such as an illustration or into a frame with a blue area enclosed by the frame.

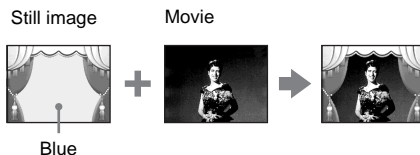

- 1 Check that you have a “Memory Stick Duo” with the still image to be superimposed and a tape (only if you are recording on tape) in your camcorder.

- 2 Slide the POWER switch repeatedly to select the CAMERA-TAPE mode (when you are recording on a tape) or the CAMERA-MEMORY mode (when you are recording on a “Memory Stick Duo”).

- 3 Touch [P-MENU].

- 4 Touch [MEMORY MIX].

If the item is not displayed on the screen, touch \uparrow / \downarrow . If you cannot find it, touch [MENU], and select it from the PICT. APPLI. menu.

The still image stored in the “Memory Stick Duo” will be displayed on the thumbnail screen.

Thumbnail screen

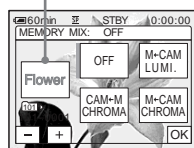

- 5 Touch \leftarrow (previous)/ \rightarrow (next) to select the still image to overlap.

→ continued

6 Touch the desired effect.

The still image is superimposed on the movie which is currently displayed on the LCD screen.

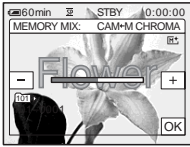

7 Touch **[-]** (decrease)/**[+]** (increase) to adjust the following.

For **[M←CAM LUMI.]**

The color scheme of the bright area in the still image which is to be swapped into a movie. When you want to record only the still image stored on the “Memory Stick Duo” to a tape, touch **[+]** on the screen in **[M←CAM LUMI.]** until the bar indicator is extended fully to the right side.

For **[CAM←M CHROMA]**

The color scheme of the blue area in the movie.

For **[M←CAM CHROMA]**

The color scheme of the blue area in the still image which is to be swapped into a movie.

8 Touch **[OK]** twice. **[M+]** appears.

9 Start recording.

When you are recording on a tape

Press REC START/STOP.

When you are recording on a “Memory Stick Duo”

Press PHOTO fully.

- When you use the MEMORY MIX function in the mirror mode (p. 29), the picture on the LCD screen appears normally, without being mirror-reversed.
- You may not be able to play back pictures modified on your computer or recorded with other camcorders on your camcorder.

Tip

- The supplied SPVD-012 USB Driver CD-ROM contains sample images for use in MEMORY MIX operations. Refer to the supplied “Computer Applications Guide” for details.

To cancel MEMORY MIX

Follow steps 3 and 4, then touch **[OFF]** in step 5.

Notes

- When the overlapping still image has a large amount of white, the image in the thumbnail screen may not be clear.

Searching for the starting point

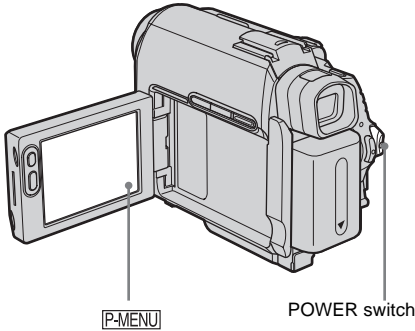

Searching for the last scene of the most recent recording – END SEARCH

This function is handy when you have played back the tape, for example, but want to start recording right after the most recently recorded scene. When you use a cassette without Cassette Memory, the END SEARCH function will not work once you eject the cassette after you have recorded on the tape. If you use a cassette with Cassette Memory, it will function even when you have ejected the cassette.

1 Slide the **POWER** switch repeatedly to select the **CAMERA-TAPE** mode.

2 Touch .

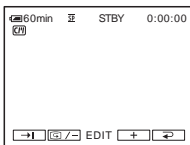

3 Touch .

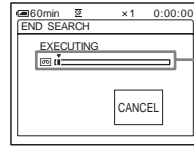

Appears only with a cassette with Cassette Memory

The last scene of the most recent recording is played back for about 5 seconds, and the camcorder enters the standby mode at the point where the last recording has finished.

To cancel the operation

Touch [CANCEL].

Note

- The END SEARCH function will not work correctly when there is a blank section between recorded sections on the tape.

Tip

- You can do this operation also by selecting [END SEARCH] in the menu setting. When PLAY/EDIT mode is selected, you can do this operation by selecting [END SEARCH] short-cut on  (p. 62).

Searching manually – EDIT SEARCH



You can search for the start point while viewing the pictures on the screen. The sound is not played back during the search.

1 Slide the **POWER** switch to select the **CAMERA-TAPE** mode.

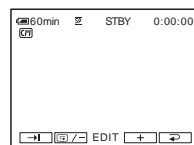
2 Touch .



→ continued

-
- 3 Keep touching  /  (to go backward) /  (to go forward) and release it at the point where you want the recording to start.
-

Reviewing the most recently recorded scenes – Rec review

You can view a few seconds of the scene recorded just before you stopped the tape.

-
- 1 Slide the **POWER** switch repeatedly to select the **CAMERA-TAPE** mode.
-

- 2 Touch .

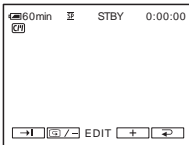

-
- 3 Touch  /  once.

The last few seconds of the most recently recorded scene are played back. Then, your camcorder is set to the standby mode.

Viewing movies recorded on a tape

Make sure you have a recorded cassette inserted into your camcorder. Some of the operations are possible using the Remote Commander or using the touch panel. When you want to play back recordings on your TV, see page 59.

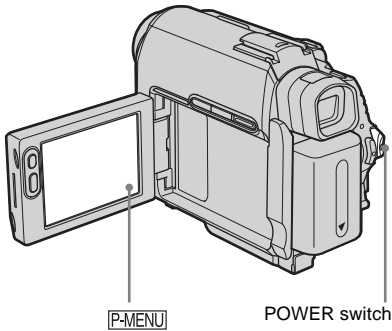

Tip

- Performing Easy Handycam operation, even first time users can play back easily. For details, see page 54.

1 Open the LCD panel.

2 Slide the POWER switch repeatedly to select the PLAY/EDIT mode.

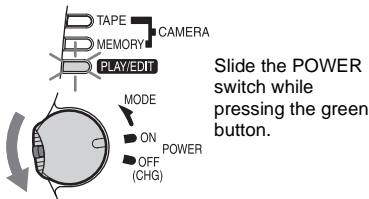

3 Touch (rewind) to go to the point you want to view.

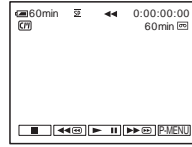





4 Touch (play) to start playback.

To adjust the volume

1 Touch .

2 Touch .

If the item is not displayed on the screen, touch /. If you cannot find it, touch  [MENU], and select it from the  (STANDARD SET) menu.

3 Adjust the volume by touching (decrease) / (increase), then touch .



To stop playback

Touch  (stop).

To pause

Touch  (pause) during playback. Touch it again to restart the playback. Playback stops automatically when the pause mode continues for more than 5 minutes.

To fast forward or rewind

Touch  (fast forward) or  (rewind) in stop mode.

To review movies on the viewfinder

Close the LCD panel. Then, extend the viewfinder.

→ continued

Indicators displayed during tape playback

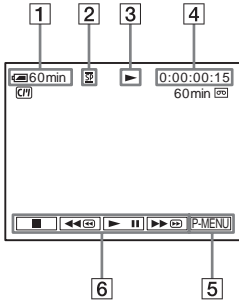

- 1 Remaining battery
- 2 Recording mode (SP or LP)
- 3 Tape transport indicator
- 4 Time code (hour: minute: second: frame) or tape counter (hour: minute: second)
- 5 Personal Menu button (p. 62)
- 6 Video operation buttons

When a “Memory Stick Duo” has been inserted, [■] (stop) changes to [◀▶PB] (“Memory Stick” playback) when you stop playback.

Note

- If you press REC START/STOP (p. 137) during tape playback, a movie recorded on the tape is recorded on the “Memory Stick Duo” (MPEG MOVIE EX).

Playing back in various modes

To fast forward or rewind during playback – Picture search

Keep on touching [▶▶] (fast forward) or [◀◀] (rewind) during playback.

To resume normal playback, release the button.

To view the picture while fast forwarding or rewinding – Skip scan

Keep on touching [▶▶] (fast forward) or [◀◀] (rewind) while fast forwarding or rewinding the tape.

To resume fast forwarding or rewinding, release the button.

To play back in various modes

You will not hear the recorded sound. Also, you may see mosaic-like images of the previously played picture remaining on the screen.

1 During playback or playback pause, touch [P-MENU].

2 Touch [VAR. SPD PB].

If the item is not displayed on the screen, touch [▲]/[▼]. If you cannot find it, touch [MENU], and select it from the [EDIT/PLAY] menu.

3 Select a playback mode.

To return to the normal playback mode, touch [▶▶] (play/pause) twice (once from frame playback).

To	Touch
change the playback direction*	[◀◀] (frame) during playback.
play back slowly**	[SLOW▶] (slow) during playback. To reverse direction 1 Touch [◀◀] (frame). 2 [SLOW▶] (slow).
play back 2 times faster (double speed)	[x2] (double speed) during playback. To reverse direction 1 Touch [◀◀] (frame). 2 [x2] (double speed).
play back frame by frame	[>▶] (frame) during playback pause. To reverse direction, touch [◀◀] (frame) again during frame playback.

*Horizontal lines may appear at the top, bottom, or in the center of the screen. This is not a malfunction.

**Pictures output from the DV Interface cannot be played back smoothly in slow mode.

4 Touch [◀], then [X].

Viewing recordings with added effects – Digital effect

You can apply [STILL], [FLASH], [LUMI. KEY], and [TRAIL] effects when viewing recorded pictures. For details on each effect, see page 43.

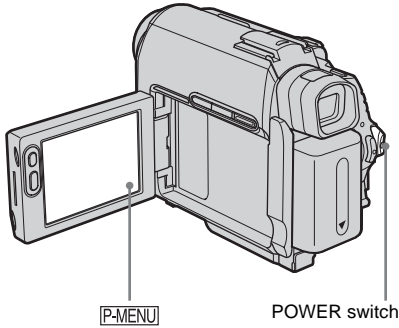

To cancel Digital effect

Follow steps 2 to 4, then select [OFF] in step 5.

Note

- You cannot add effects to externally input pictures. Also, you cannot output pictures edited with digital effects via the  DV Interface.

Tip



- You cannot record the pictures edited using special effects on the tape in your camcorder, but you can copy them to a “Memory Stick Duo” (p. 95) or another tape (p. 93).

1 Slide the **POWER** switch repeatedly to select the **PLAY/EDIT** mode.

2 Touch **P-MENU** while the picture you want to add the effect to is displayed.

3 Touch **[MENU]**.

4 Select  (**PICT. APPLI.**), then **[D.EFFECT]** by touching / and touch **[OK]**.

5 Select an effect, then adjust the effect by touching  (decrease)/ (increase).

6 Touch **[OK]** twice, then **[X]**.
 appears.

Viewing recordings on a "Memory Stick Duo"

You can view pictures one at a time on the screen. When you have a lot of pictures, you can list them to search through them easily. Make sure you have a recorded "Memory Stick Duo" inserted into your camcorder. When you want to play back a recorded picture on your TV, see page 59.

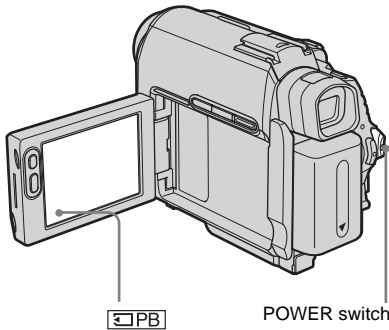

1 Open the LCD panel.

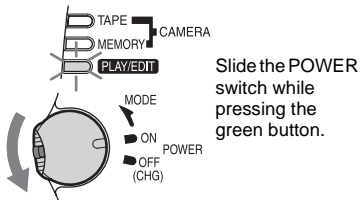

2 Slide the **POWER** switch repeatedly to select the **PLAY/EDIT** mode.

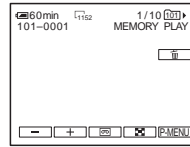

3 Touch .

The most recently recorded picture appears on the screen.



4 Touch  (previous)/  (next) to select a picture.

Screen example (movies):

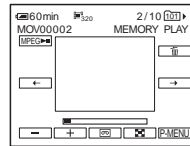







When you view a movie, touch  when the selected movie appears on the screen.

To adjust the volume of movies

1 Touch .

2 Touch **[VOLUME]**.

If the item is not displayed on the screen, touch  / . If you cannot find it, touch , and select it from the  (STANDARD SET) menu.

3 Adjust the volume by touching  (decrease)/  (increase), then touch .

To stop or pause movies

Touch . Touch it again to restart the playback.

To delete pictures

See "Deleting recorded pictures" (p. 106).

Indicators displayed during “Memory Stick Duo” playback

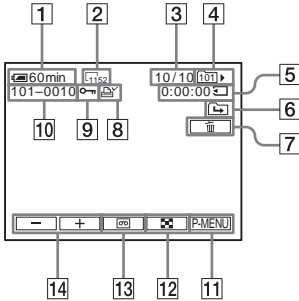

- 1 Remaining battery
- 2 Image size
- 3 Picture number/Total number of recorded pictures in the current playback folder
- 4 Playback folder
- 5 Playing time (movies only)
- 6 Previous/next folder icon
The following indicators appear when the first or last picture of the current folder is displayed and when there are multiple folders on the same “Memory Stick Duo.”
 ◀ : Touch [−] to move to the previous folder.
 ▶ : Touch [+] to move to the next folder.
 ◀▶ : Touch [−]/[+] to move to either the previous or the next folder.
- 7 Image delete button
- 8 Print mark (still images only) (p. 108)
- 9 Image protection mark (p. 107)
- 10 Data file name
- 11 Personal Menu button
- 12 Index screen display button
- 13 Tape playback select button
- 14 Picture select button

Notes

- Folders that you have created on a computer, renamed folders, and modified pictures may not appear on the screen.
- While playing back movies on a “Memory Stick Duo,” the only menu items available will be those with short cuts on the Personal Menu. In order to use other menu items, add them to the Personal Menu.

Tip

- Once you record a picture in a folder, the same folder will be set as the default folder for playback. You can select a playback folder in the menu (p. 73).

Playing back in various modes from a “Memory Stick Duo”

Using the screen in step 4 in “Viewing recordings on a “Memory Stick Duo”” (p. 52), the following operations are available.

To search for a scene in a movie

You can divide a movie into a maximum of 60 scenes in order to start playback from a particular scene. The number of scenes you can divide the movie into depends on the length of the movie.

- 1 Touch [◀] (previous)/[▶] (next) to select a scene from which to start the playback.

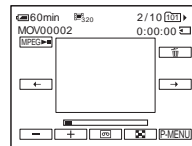

- 2 Touch [MPEG-II].

To display 6 pictures at a time, including movies – Index Screen



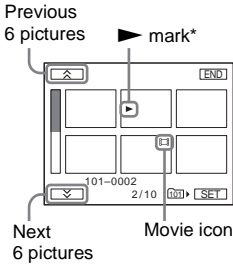

Touch .



* The picture displayed before switching to the index screen.

To return to the single display mode, touch the picture that you want to display.

To view pictures in other folders in the index screen

- 1 Touch .
- 2 Touch .
- 3 Touch [PB FOLDER].
- 4 Select a folder with /, then touch .

Playing back with ease – Easy Handycam

Easy Handycam operation allows easy playback for even first time users by providing only the basic functions for playback. Also screen font size increases for easy viewing. Make sure you have a recorded cassette or a recorded “Memory Stick Duo” inserted into your camcorder.

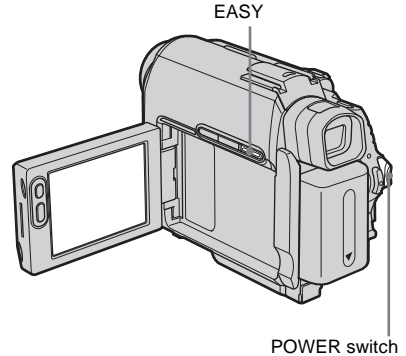

1 Open the LCD panel.

2 Slide the POWER switch repeatedly to select the PLAY/EDIT mode.

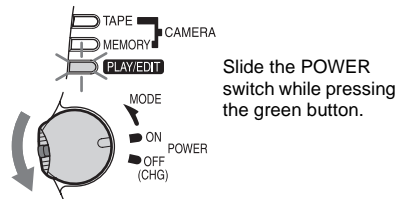

3 Press EASY.

The EASY lights up in blue.

4 Play back pictures.

When playing back on a tape

The following buttons can be operated.
 (play/pause)/ (fast forward)/
 (stop)/ (rewind)

You can operate these operations and SLOW▶▶ on the Remote Commander.

When playing back on a “Memory Stick Duo”

Touch .

The following buttons can be operated.

(previous)/ (next)/ (play/pause for movie)/ (delete)

You can control playback with the Remote Commander.

To cancel Easy Handycam operation

Press EASY again.

Note

- You cannot turn Easy Handycam operation on or off during communication with another device via USB cable.

Making full use of Easy Handycam operation

1 Touch [MENU].

The available menu items are displayed on the screen

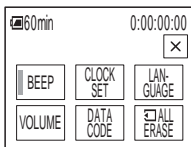

2 Touch the desired item.

3 Select the desired setting.

For [CLOCK SET]

1 Set [Y] (year) with /, then touch .

2 Set [M] (month), [D] (day), hour and minutes in the same way as [Y] (year), then touch .

For [LANGUAGE]

Select the desired language with /, then touch .

For [BEEP]

See page 87.

For [VOLUME]

Adjust the volume by touching (decrease)/ (increase), then touch .

For [DATA CODE]

During playback, you can view the date/time data.

Touch [DATE/TIME], then touch .

For [ALL ERASE]

You can delete all the images on the “Memory Stick Duo.”

Touch [YES].

Tip

- During Easy Handycam operation, you can also do the followings:
 - “Playing the picture on a TV” (p. 59)
 - “Dubbing to another tape” (p. 93)

Various playback functions

You can magnify a small subject in a recording and display it on the screen. You can also display the recorded date and the name of the folder in which the picture is recorded.

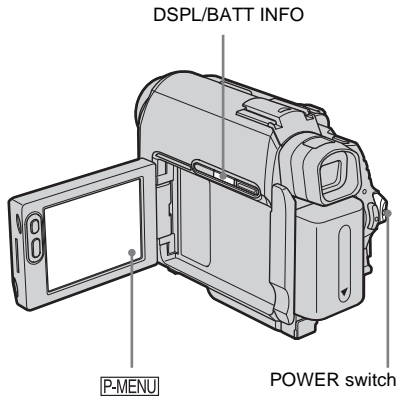

Magnifying pictures – Tape playback zoom/Memory playback zoom

You can magnify movies recorded on a tape or still images stored on a “Memory Stick Duo.”

- 1 Slide the **POWER** switch repeatedly to select the **PLAY/EDIT** mode.
- 2 Touch **[P-MENU]**.

- 3 Touch **[MENU]**.

- 4 Select **[PICT. APPL.]**, then **[PB ZOOM]** by touching **[▲]/[▼]** and touch **[OK]**.

Tape playback zoom screen



Memory playback zoom screen

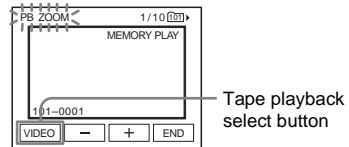

- 5 Play back the still picture or movie, and touch the screen at the point you want to magnify within the displayed frame.

The picture is magnified approximately twice the original size and centered at the point you touched on the screen. When you touch another place, the point you touched becomes the center.

- 6 Adjust the zoom ratio using the power zoom lever.

You can select the zoom ratio from approximately 1.1 to 5 times the original size. Touch W to decrease, or T to increase the ratio.

To cancel the operation

Touch [END].

🔊 Notes

- You cannot use Tape PB zoom together with:
 - Digital effect
 - Picture effect ([PICT. EFFECT])
- You cannot magnify externally input pictures. Also, you cannot output the magnified pictures via the DV Interface.

💡 Tip

- If you press DSPL/BATT INFO during the playback zoom operation, the frame will disappear.

Displaying the screen indicators

You can choose to display the time code, tape counter, and other information on the screen.

Press DSPL/BATT INFO.

The indicator switches on or off as you press the button.

💡 Tip

- You can display the screen indicators during playback on a TV. Select the  (STANDARD SET) menu, [DISPLAY], then [V-OUT/PANEL] (p. 87).



Displaying the date/time and camera settings data – Data code

During playback, you can view the date/time data and the camera settings data ([CAMERA DATA]) that are automatically recorded while recording pictures on a tape or a “Memory Stick Duo.”

1 Slide the **POWER** switch repeatedly to select the **PLAY/EDIT** mode.

2 Touch **[P-MENU]** during playback or playback pause.

3 Touch **[DATA CODE]**.

If the item is not displayed on the screen, touch /. If you cannot find it, touch [MENU], and select it from the  (STANDARD SET) menu.

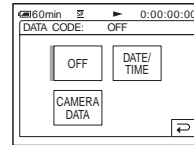

4 Select **[CAMERA DATA]** or **[DATE/TIME]** then touch **[OK]**.

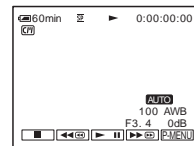

To hide the date/time or camera settings data

Follow steps 2 and 3, and select [OFF] in step 4.

Camera settings data display

In the date/time data display, the date and time is displayed in the same area.

If you record the picture without setting the clock, [--- -- ----] and [--:--:--] will appear.

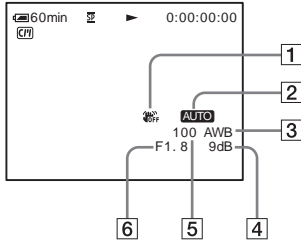

1 SteadyShot off*

2 Exposure*

3 White balance*

4 Gain*

5 Shutter speed

6 Aperture value

* Appears only during tape playback

Note

- Camera setting data do not appear when movies on a "Memory Stick Duo" are played back.

Tips

- Exposure adjustment value (0EV) appears when a "Memory Stick Duo" is played back.
-  appears for the picture recorded using an external flash (optional).

Playing the picture on a TV

Connect your camcorder to a TV using the supplied A/V connecting cable as shown in the following illustration. Connect the supplied AC Adaptor to the wall outlet for the power supply (p. 16). Refer also to the instruction manuals supplied with the devices to be connected. To copy to another tape, see page 93.

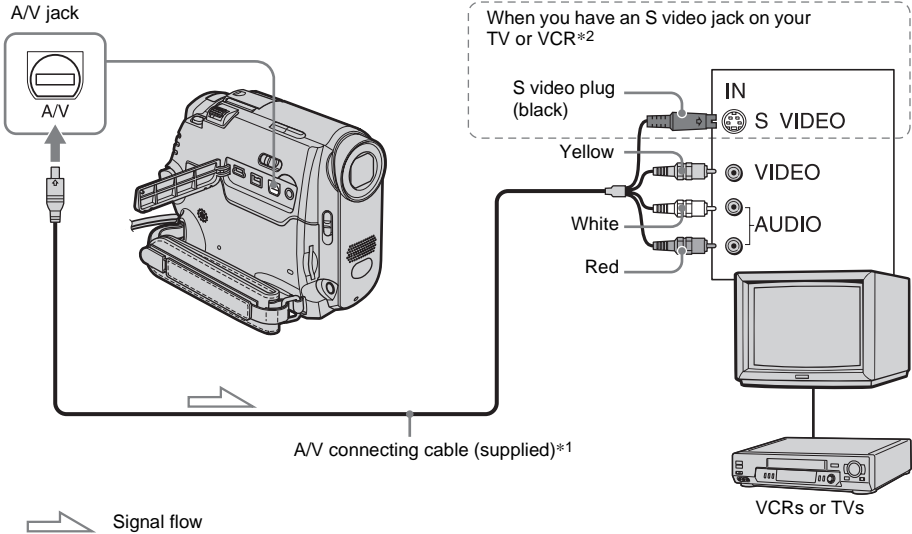

Playback

- *1 The supplied A/V connecting cable has a video plug and an S video plug for the video connection.
- *2 This connection produces higher quality DV format pictures. When there is an S video jack on the device to be connected, connect the S video plug to that jack instead of using the yellow video plug. The audio will not be output when you connect with the S video plug alone.

When your TV is connected to a VCR

Connect your camcorder to the LINE IN input on the VCR using the A/V connecting cable. Set the input selector on the VCR to LINE.

When your TV is monaural (When your TV has only one audio input jack)

Connect the yellow plug of the A/V connecting cable to the video input jack and connect the white or the red plug to the audio input jack of your TV or VCR.

When you want to play the sound in monaural mode, use a connecting cable (optional) for that purpose.

Locating a scene on a tape for playback

Searching quickly for a desired scene – Zero set memory

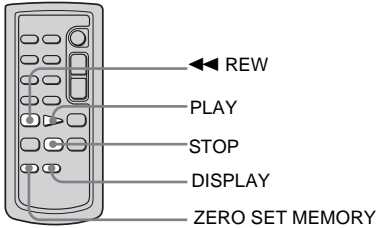

- 1 **During playback, press ZERO SET MEMORY on the Remote Commander at the point you want to locate later on.**

The tape counter is reset to “0:00:00” and **→0←** appears on the screen.

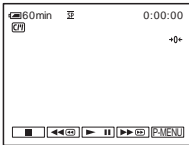

If the tape counter is not displayed, press DISPLAY on the Remote Commander.

- 2 Press  (stop) when you want to stop playback.

- 3 Press **◀◀ REW.**

The tape stops automatically when the tape counter reaches “0:00:00.”

- 4 **Press PLAY.**

The playback starts from the point designated “0:00:00” on the tape counter.

To cancel the operation

Press ZERO SET MEMORY on the Remote Commander again.

Notes

- There may be a discrepancy of several seconds between the time code and the tape counter.
- Zero set memory will not function correctly if there is a blank section between recorded sections on the tape.

Searching for a scene using Cassette Memory – Title search

You can locate a scene where you have added a title (p. 80).

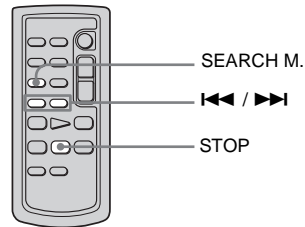

- 1 **Slide the POWER switch repeatedly to select the PLAY/EDIT mode.**

- 2 **Press SEARCH M. on the Remote Commander repeatedly to select [TITLE SEARCH].**

- 3 Press **◀◀** (previous)/**▶▶** (next) on the Remote Commander to select a title that you want to play.

Playback starts automatically from the selected title.

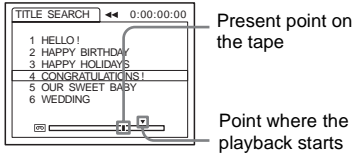

To cancel the operation

Press STOP on the Remote Commander.

Notes

- You cannot use Title search when [C/M]SEARCH is set to [OFF] on the (EDIT/PLAY) menu (it is set to [ON] by default) (p. 80).
- The Title search will not function correctly when there is a blank section between recorded sections on the tape.

Searching for a scene by date of recording – Date search

When you are using a cassette with Cassette Memory, you can locate a scene by the recording date ([C/M]SEARCH is set to [ON] by default). When you are using a cassette that does not have Cassette Memory, you can locate the point where the recording date changes.

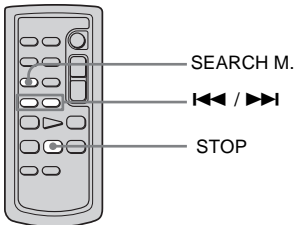

- 1 Slide the POWER switch repeatedly to select the PLAY/EDIT mode.

- 2 Press **SEARCH M.** on the Remote Commander repeatedly to select [DATE SEARCH].

- 3 Press **◀◀** (previous)/**▶▶** (next) on the Remote Commander to select a recording date.

When your cassette has Cassette Memory, you can select the recording date itself. When your cassette does not have Cassette Memory, you can select the previous or the next date of the present point on the tape. Playback starts automatically from the point where the date changes.

Screen example

(when the cassette has Cassette Memory):

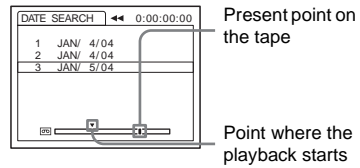

To cancel the operation

Press STOP on the Remote Commander.

Notes

- If one day's recording is less than 2 minutes, your camcorder may not accurately find the point where the recording date changes.
- The Date search will not function correctly when there is a blank section between recorded sections on the tape.
- You can record date/time data for up to 6 days. When you have recorded for more than 7 days on a tape, locate the date without using the Cassette Memory. To turn off the Cassette Memory, select the (EDIT/PLAY) menu, [C/M]SEARCH, and then [OFF] (p. 80).

►Advanced operations

Using the Menu

Selecting menu items

You can change various settings or make detailed adjustments using the menu items displayed on the screen.

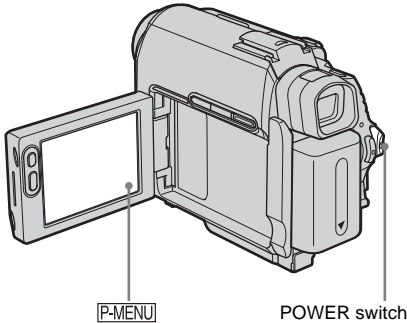

1 Turn on the power (p. 19).

2 Touch **P-MENU**.

The Personal Menu appears. Items that are used often are displayed as short-cuts.



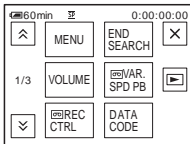

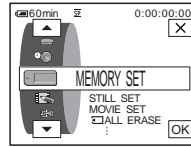

Example: PLAY/EDIT mode's Personal Menu



3 Touch **[MENU]** to display the menu index screen.



4 Select the icon of the desired menu with **▲/▼**, then touch **OK**.

-  CAMERA SET (p. 64)
-  MEMORY SET (p. 70)
-  PICT. APPLI. (p. 74)
-  EDIT/PLAY (p. 79)
-  STANDARD SET (p. 83)
-  TIME/LANGU. (p. 88)

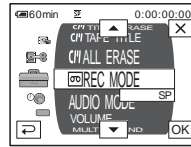

5 Select the desired item with **▲/▼**, then touch **OK**.

You can also touch the item directly to select it.



You can scroll and see all items.

The available items vary depending on the power mode of your camcorder.

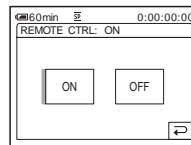
Unavailable items will be grayed out.



6 Select the desired setting.

 changes to . If you decide not to change the setting, touch  to return to the previous screen.

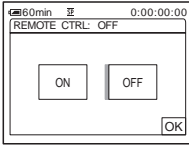



7 Touch , then to hide the menu screen.

You can also touch  (return) to go back a screen each time you touch the button.



To use the short-cuts of the Personal Menu

The available items vary depending on the power mode of your camcorder. Unavailable items will be grayed out.

You can customize the short-cuts (p. 89).

- 1 Touch .
- 2 Touch the desired item.
- 3 Select the desired setting, then touch .

Tips

- When the PLAY/EDIT mode is selected, touch  on the screen displayed after step 2 (p. 62) to display the video operation screen. Touch  to return to the previous screen.
- It is convenient if the items you often use appear as short-cuts on the Personal Menu. To customize the Personal Menu, see page 89.

Using the (CAMERA SET) menu

– PROGRAM AE/WHITE BAL./16:9 WIDE, etc.

You can select items listed below on the CAMERA SET menu. To select items, see “Selecting menu items” (p. 62).





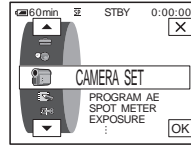







The default settings are marked with ▷. The indicators in parentheses appear when the

setting is selected. The settings you can adjust vary depending on the power mode of your camcorder. The screen shows the items you can currently operate. Unavailable items will be grayed out.



PROGRAM AE

You can record pictures easily in a situation that requires various techniques by selecting the following settings.

▷ AUTO	Select this when not using PROGRAM AE.	
SPOTLIGHT* (spotlight) ()	Select to prevent people's faces from appearing excessively white when subjects are lit by strong light, such as in a theater or at a wedding.	
PORTRAIT (soft portrait) ()	Select to bring out the subject such as people or flowers while creating a soft background.	
SPORTS* (sports lesson) ()	Select to minimize shake when shooting fast-moving subjects such as in tennis or golf.	
BEACH&SKI* (beach & ski) ()	Select to prevent people's faces from appearing dark in strong light or reflected light, such as at a beach in midsummer or on a ski slope.	
SUNSET&MOON** (sunset & moon) ()	Select to maintain the atmosphere of situations such as sunsets, general night views, fireworks, and neon signs.	
LANDSCAPE** (landscape) ()	Select when shooting distant subjects such as mountains. This setting also prevents your camcorder from focusing on glass or metal mesh in windows that comes in between the camcorder and the subject.	

- * Your camcorder is adjusted to focus only on subjects in the middle to far distance.
- **Your camcorder is adjusted to focus only on distant subjects.

Note

- [SPORTS] (sports lesson) will not work when the POWER switch is set to CAMERA-MEMORY.

SPOT METER

See page 37 for details.

EXPOSURE

See page 38 for details.

WHITE BAL.

You can adjust the color balance to the brightness of the recording environment.

▷ AUTO	Select when you want to record with the white balance adjusted automatically.
OUTDOOR (☀)	<ul style="list-style-type: none"> • Select when recording a sunset/sunrise, general night views, neon signs, or fireworks. • Select when under daylight fluorescent lamps.
INDOOR (💡)	<ul style="list-style-type: none"> • Select when recording at a party or in studios where lighting conditions change quickly. • Select when under video lamps such as those in a studio, under sodium lamps, mercury lamps or warm white fluorescent lamps.
ONE PUSH (📷)	Select when you want to record with the white balance adjusted according to the ambient light.

- 1 Select [ONE PUSH].**
- 2 Frame a white object such as a piece of paper, to fill the screen under the same lighting conditions as you will shoot the subject.**
- 3 Touch [📷].**
 📷 flashes quickly.
 When the white balance has been adjusted and stored in the memory, the indicator stops flashing.

Notes

- Do not shake your camcorder while 📷 is flashing quickly.
- When 📷 flashes slowly, the white balance has not been set, or could not be set.
- If 📷 keeps flashing even after you have touched [OK], set [WHITE BAL.] to [AUTO].

→ continued

Notes

- You cannot use the white balance together with the NightShot plus, or Super NightShot plus function.
- The setting returns to [AUTO] when you disconnect the power source from your camcorder for more than 5 minutes.

Tips

- For better color balance adjustment when [WHITE BAL.] is set to [AUTO], aim your camcorder at a nearby white object for about 10 seconds after setting the POWER switch to CAMERA-TAPE when:
 - You remove the battery pack for replacement.
 - You bring your camcorder outdoors from inside the house while using fixed exposure, or bring your camcorder in from outside.
- Redo the [ONE PUSH] procedure when:
 - You changed the [PROGRAM AE] settings when [WHITE BAL.] is set to [ONE PUSH].
 - You brought your camcorder outdoors from inside the house, or vice versa.
- Set [WHITE BAL.] to [AUTO] or [ONE PUSH] under white or cool white fluorescent lamps.

AUTO SHUTTER

▷ON	Select to automatically activate the electronic shutter to adjust the shutter speed when recording in bright conditions.
OFF	Select when recording without using the electronic shutter.

SPOT FOCUS

See page 40 for details.

FOCUS

See page 41 for details.

FLASH SET

Note that these settings will not function with external flashes that do not support the following settings.

FLASH MODE

▷ON	Select to trigger the flash (optional) regardless of the brightness of the surroundings.
ON 	DCR-HC40: Select to trigger the flash (optional) regardless of the brightness of the surroundings. The flash goes off prematurely to reduce the red-eye phenomenon.
AUTO	Select to trigger the flash (optional) automatically.

AUTO 	DCR-HC40: Select to trigger the flash (optional) automatically. The flash goes off prematurely to reduce the red-eye phenomenon.
--	---

Note

- DCR-HC40:
If the flash is not capable of preventing the red-eye phenomenon, you can select only [ON] or [AUTO].

FLASH LEVEL

You can select an appropriate flash setting for recording with an external flash (optional).

HIGH ( +)	Select to make the flash level higher than the standard setting.
--	--

▷NORMAL ()	Standard setting.
---	-------------------

LOW ( -)	Select to make the flash level lower than the standard setting.
---	---

Note

- The setting returns to [NORMAL] when you disconnect the power source from your camcorder for more than 5 minutes.

SUPER NSPLUS

See page 39 for details.

NS LIGHT

When using the NightShot plus function to record, you can record clearer pictures by using the NightShot Light to emit infrared rays (invisible).

▷ON	Select to use the NightShot Light (p. 39).
-----	--

OFF	Select to disable the NightShot Light (p. 39).
-----	--

COLOR SLOW S

See page 39 for details.

SELF-TIMER

See page 30, 33 for details.

DIGITAL ZOOM

You can select the maximum zoom level in case you want to zoom to a level greater than 10 times while recording on a tape. Note that the image quality decreases when you are using the digital zoom. This function is useful when recording enlarged pictures of a distant subject, such as a bird.



The right side of the bar shows the digital zooming zone.
The zooming zone appears when you select the zooming level.

▷OFF	Select to deactivate the digital zoom. Up to 10 times zoom is performed optically.
20 ×	Select to activate the digital zoom. 10 times through 20 times zoom is performed digitally.
120 ×	Select to activate the digital zoom. 10 times through 120 times zoom is performed digitally.

16:9 WIDE

You can record a 16:9 wide picture on the tape to watch on a 16:9 wide-screen TV ([16:9WIDE] mode).

With this function [ON], your camcorder offers even wider angles when you move the power zoom lever to the “W” side than recording in [OFF].

When you connect your camcorder to the S video input jack of a TV compatible with the ID-1/ID-2 system and play the tape, the TV switches to full mode automatically.

Refer also to the manuals supplied with your TV.

When viewed on the LCD screen/viewfinder

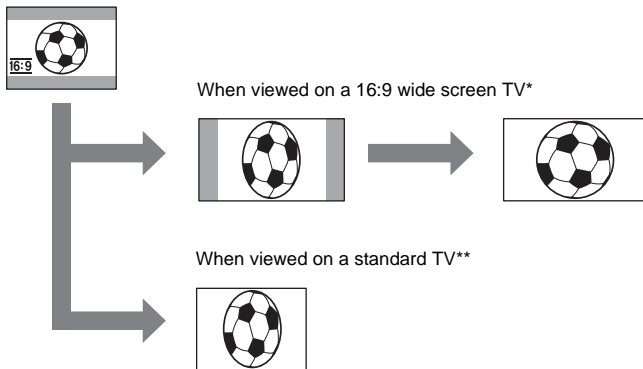

* Picture appears in full screen when the wide-screen TV switches to full mode.

**Played in 4:3 mode. When you play a picture in the wide mode, it appears as you have seen on the LCD screen or in the viewfinder.

▷OFF	Standard setting (to record pictures to play back on a 4:3 TV). The recorded picture will not be wide.
ON (16:9)	Select to record a picture to be played back on a 16:9 wide TV. The recorded picture will be played in full mode when you connect to your TV using an S video input jack compatible with ID-1/ID-2 systems.

Tips

- The ID-1 system sends aspect ratio information (16:9, 4:3, or letter box) by inserting signals between video signals.
- The ID-2 system sends a copyright protection signal with the ID-1 signals inserted between video signals in an analog connection.

STEADYSHOT

You can select this function to compensate for camera-shake.

▷ON	Standard setting (enable the SteadyShot function).
OFF ()	Select to deactivate the SteadyShot function. Select to shoot a stationary subject with a tripod, or when using a conversion lens (optional). Natural pictures are produced.

Using the (MEMORY SET) menu

– BURST/QUALITY/IMAGE SIZE/ALL ERASE/NEW FOLDER, etc.

You can select items listed below on the MEMORY SET menu. To select items, see “Selecting menu items” (p. 62). The default settings are marked with ▷. The indicators in parentheses appear when the

setting is selected. The settings you can adjust vary depending on the power mode of your camcorder. The screen shows the items you can currently operate. Unavailable items will be grayed out.

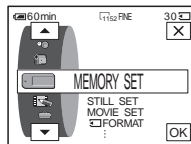



STILL SET

■ BURST

For DCR-HC40:

You can record several still images one after another. The number of images you can record changes with the image size and space available on the “Memory Stick Duo” you are using.

1 Select [NORMAL] or [EXP. BRKTG], and then touch .

▷OFF	Select when not recording continuously.
NORMAL ()	Select to record from 4 (1152 × 864 image size) to 13 (640 × 480 image size) images continuously at approximately 0.5-second intervals.
EXP. BRKTG ()	Select to record 3 images consecutively with different exposures at approximately 0.5-second intervals. You can compare the 3 images and select an image recorded in the best exposure.

2 Touch .

3 Press PHOTO fully.

In the [NORMAL] setting, the maximum number of images are recorded as long as you are pressing PHOTO fully.

Notes

- The flash (optional) will not function while you are recording images continuously.
- The maximum number of images will be recorded in the self-timer mode or when you are operating with the Remote Commander.
- [EXP. BRKTG] will not function when you have space for fewer than 3 images remaining on the “Memory Stick Duo.”
- When it is hard to see the difference between the images recorded in [EXP. BRKTG] mode on the LCD screen, connect your camcorder to your TV or a computer.

■ QUALITY

▷FINE (FINE)	Select to record still images with the fine image quality (compressed to about 1/4).
STANDARD (STD)	Select to record still images with the standard image quality (compressed to about 1/10).

■ IMAGE SIZE

For DCR-HC40:

▷1152 × 864 (L 1152)	Select to record still images for playing on a large screen. This setting can be selected only in the CAMERA-MEMORY mode.
640 × 480 (□ 640)	Select to record many still images or for playing on a small screen.

MOVIE SET

□ IMAGE SIZE

▷320 × 240 (□ 320)	Select to record movies for playing on a large screen, or to record clearer pictures.
160 × 112 (□ 160)	Select to record for longer time.

□ REMAINING

▷AUTO	Select to display the remaining capacity of the “Memory Stick Duo” in the following cases: <ul style="list-style-type: none">• After inserting a “Memory Stick Duo” with the POWER switch in the CAMERA-MEMORY mode (for about 5 seconds).• When the remaining capacity of the “Memory Stick Duo” is less than 2 minutes after the CAMERA-MEMORY mode is selected.• At the starting or ending point of the movie (for approximately 5 seconds).
ON	Select to always display the remaining capacity of the “Memory Stick Duo.”

◀ ALL ERASE

You can delete all the pictures on a “Memory Stick Duo” that are not write-protected. To delete pictures one by one, see page 106.

1 Select [ALL FILES] or [CURRNT FOLDER].

ALL FILES	Select to delete all the images on the “Memory Stick Duo.”
CURRNT FOLDER	Select to delete all the images in the selected playback folder.

2 Touch [YES] twice.

To cancel deletion of all pictures, select [NO].

3 Touch [X].

→ continued

Notes

- The folder will not be deleted even when you delete all the pictures in the folder.
- Do not do any of the following while [ Erasing all data...] is displayed:
 - Move the POWER switch to select other power modes.
 - Operate any buttons.
 - Eject the “Memory Stick Duo.”

FORMAT

The supplied or newly purchased “Memory Stick Duo” has been formatted at the factory, and does not require formatting.

For details on the “Memory Stick Duo,” see page 126.

1 Touch [YES] twice.

To cancel formatting, select [NO].

2 Touch [].

Notes

- Do not do any of the following while [ Formatting...] is displayed:
 - Move the POWER switch to select other power modes.
 - Operate any buttons.
 - Eject the “Memory Stick Duo.”
- Formatting erases everything on the “Memory Stick Duo” including protected image data and newly created folders.

FILE NO.

▷SERIES	Select to assign file numbers in sequence even if the “Memory Stick Duo” is replaced with another one. The file number is reset when a new folder is created or the recording folder is replaced with another.
RESET	Select to reset the file number to 0001 each time the “Memory Stick Duo” is changed.

NEW FOLDER

You can create a new folder (102MSDCF to 999MSDCF) on a “Memory Stick Duo.” When a folder is full (a maximum of 9999 images are stored) a new folder is automatically created.

1 Touch [YES].

A newly created folder will be numbered in sequence after the last folder number.



To cancel creation, select [NO].

2 Touch [].



Notes

- You cannot delete the created folders using your camcorder. You will have to format the “Memory Stick Duo” (p. 72), or delete them using your computer.
- The number of pictures that can be recorded on a “Memory Stick Duo” decreases as the number of folders increases on the “Memory Stick Duo.”

REC FOLDER

As the default setting, pictures are saved in the 101MSDCF folder. You can select a folder to save your pictures. Create new folders from the [NEW FOLDER] menu, then select the folder to be used for recording with / and touch . When you have a lot of pictures, you can search for the desired picture easily when you sort them in folders.

PB FOLDER

Select the playback folder with /, then touch .

Using the (PICT. APPLI.) menu – PICT.

EFFECT/SLIDE SHOW/FRAME REC/INTERVAL REC/INT. REC–STL, etc.

You can select items listed below on the PICT. APPLI. menu. To select items, see “Selecting menu items” (p. 62). The default settings are marked with ▷. The indicators in parentheses appear when the

setting is selected. The settings you can adjust vary depending on the power mode of your camcorder. The screen shows the items you can currently operate. Unavailable items will be grayed out.

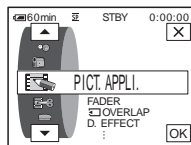

FADER

See page 42 for details.

OVERLAP



See page 43 for details.



D. EFFECT

See page 43 and 51 for details.

PICT. EFFECT

You can add special effects (such as films) to a picture before or after recording on a tape.  appears when the effect is selected.

▷OFF	Select when not using the Picture effect setting.	
NEG.ART	Select to record/play the picture with the color and brightness of the picture reversed.	
SEPIA	Select to record/play the picture appearing in sepia.	
B&W	Select to record/play the picture appearing in monochrome (black-and-white).	
SOLARIZE	Select to record/play the picture looking like an illustration with strong contrast.	

PASTEL	Select to record the picture looking like a pale pastel drawing. (This effect is not available during playback.)	
MOSAIC	Select to record picture appearing mosaic-patterned. (This effect is not available during playback.)	

Note

- You cannot add effects to externally input pictures. Also, you cannot output pictures edited with Picture effects via the DV Interface.

Tip

- You can copy pictures edited using picture effects to a “Memory Stick Duo” (p. 95) or to another tape (p. 93).

MEMORY MIX

See page 45 for details.

PB ZOOM

See page 56 for details.

SLIDE SHOW

You can play back the images stored in a “Memory Stick Duo” (or a selected playback folder) in sequence (slide show).

- Touch **[SET]**.
- Touch **[PB FOLDER]**.
- Select **[ALL FILES]** or **[CURRNT FOLDER]**, then touch **[OK]**.

▷ALL FILES (**[ALL]**) Select to execute a slide show by playing back all the images on the “Memory Stick Duo.”

CURRNT FOLDER (**[T]**) Select to execute a slide show by playing back all the images in the current playback folder selected in [PB FOLDER] (p. 73).

- Touch **[REPEAT]**.
- Touch **[ON]** or **[OFF]**, then **[OK]**.

▷ON (**[C]**) Select to repeat the slide show.

OFF Select to execute the slide show only once.

- Touch **[END]**.

→continued

7 Touch [START].

Your camcorder plays back the images recorded on the “Memory Stick Duo” in sequence.

To cancel the slide show, touch [END]. To pause, touch [PAUSE].

💡 Tips

- You can select the first picture for the slide show by touching $\boxed{-}$ / $\boxed{+}$ before touching [START].
- If movies are played in the slide show, you can adjust the volume by touching $\boxed{\text{V}}\boxed{-}$ (decrease) / $\boxed{\text{V}}\boxed{+}$ (increase).

FRAME REC

You can record pictures with a stop-motion animated effect by alternately frame recording and then moving the subject a little. Operate your camcorder using the Remote Commander to prevent camera shake.

▷OFF	Select to record in the standard recording mode.
ON (🎞️)	Select to record pictures using the FRAME REC function. 1 Select [ON], then touch $\boxed{\text{OK}}$. 2 Touch $\boxed{\times}$. 3 Press REC START/STOP. A picture (approximately 6 frames) is recorded, and your camcorder enters the standby mode. 4 Move the subject and repeat step 3.

📌 Notes

- When you use frame recording continuously, the remaining tape time will not be indicated correctly.
- The last scene will be longer than other scenes.

INTERVAL REC

You can record pictures on a tape at a selected interval, when you record flowers blooming, etc. Connect your camcorder to the wall outlet using the supplied AC Adaptor during the operation.

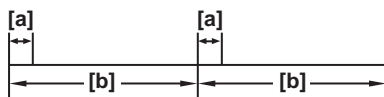

a: [REC TIME]
b: [INTERVAL]

- 1 Touch $\boxed{\text{SET}}$.**
- 2 Touch [INTERVAL].**
- 3 Select a desired interval time (30 seconds, 1, 5 or 10 minutes), then touch $\boxed{\text{OK}}$.**
- 4 Touch [REC TIME].**

- 5 Select a desired recording time (0.5, 1, 1.5 or 2 seconds), then touch **[OK]**.
- 6 Touch **[END]**.
- 7 Touch **[ON]**, then **[OK]**.

▷OFF To deactivate interval recording.

ON (📷) To record moving pictures on a tape in the selected interval.

- 8 Touch **[X]**.
📷 flashes on the screen.
- 9 Press **REC START/STOP**.
📷 stops flashing and the interval recording starts.
To cancel interval recording, select **[OFF]** in step 7.

🔔 Notes

- You cannot use the interval recording with:
 - MEMORY MIX function
 - Memory overlap
- There may be a discrepancy in recording time of up to ± 6 frames from the selected time.

🔔 Tips

- If you adjust the focus manually, you may be able to record clear pictures even if the light changes (p. 41).
- You can silence the beeps during recording (p. 87).

INT. REC-STL

This function is useful to observe the movement of clouds or the change of daylight. Your camcorder will shoot a still image at a selected interval and record it on a “Memory Stick Duo.”

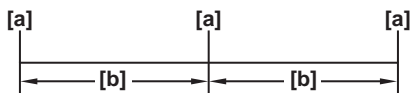

a: Shooting time
b: Interval

- 1 Touch **[SET]**.
- 2 Select a desired interval time (1, 5, or 10 minutes), then touch **[OK]**.
- 3 Touch **[ON]**, then touch **[OK]**.

▷OFF To deactivate interval recording.

ON (📷) To record still images on a “Memory Stick Duo” in the selected interval.

- 4 Touch **[X]**.
📷 flashes.
- 5 Press **PHOTO** fully.
📷 stops flashing and the interval photo recording starts.
To cancel interval photo recording, select **[OFF]** in step 3.

→ continued

DEMO MODE

When you remove both cassette and “Memory Stick Duo” from your camcorder, and select the CAMERA-TAPE mode, you can view the demonstration in about 10 minutes.

▷ON	Select to see an overview of the functions available such as when you are using this camcorder for the first time.
OFF	Select when you do not intend to use the DEMO MODE.

Note

- You cannot view the demonstration when the NIGHTSHOT PLUS switch is set to ON.

Tips

- The demonstration will be suspended in situations such as those described below.
 - When you touch the screen during the demonstration. (The demonstration starts again in about 10 minutes.)
 - When a cassette or “Memory Stick Duo” is inserted.
 - When a mode other than CAMERA-TAPE is selected.
- If [A.SHUT OFF] is set to [5 min] when the camcorder is used on the battery pack, the power will be turned off after approximately 5 minutes (p. 87).

PRINT

See page 109 for details.

Using the (EDIT/PLAY) menu - TITLE/

 TAPE TITLE, etc.

You can select items listed below on the EDIT/PLAY menu. To select items, see “Selecting menu items” (p. 62).

The default settings are marked with ▷. The settings you can adjust vary depending on the

power mode of your camcorder. The screen shows the items you can currently operate. Unavailable items will be grayed out.

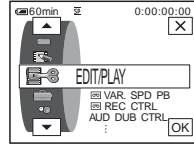

VAR. SPD PB

See page 50 for details.

REC CTRL

See page 94 and 96 for details.

AUD DUB CTRL

See page 105 for details.

PROG. EDIT

OTHER DEVICE Select to make programs and dubbing the selected scenes to a tape on a VCR (p. 97).

MEMORY STICK Select to make programs and dubbing the selected scenes to a “Memory Stick Duo” (p. 101).

REC CTRL

See page 94 and 95 for details.

BURN DVD

When your camcorder is connected to a Sony VAIO series personal computer, you can easily burn the picture recorded on the tape on a DVD (Direct Access to “Click to DVD”) using this command. See the supplied “Computer Applications Guide” for details.

→ continued

BURN VCD

When your camcorder is connected to a personal computer, you can easily burn the picture recorded on the tape on a CD-R (Direct Access to Video CD Burn) using this command. See the supplied "Computer Applications Guide" for details.

END SEARCH



EXEC	Select to activate the END SEARCH function. The most recently recorded picture is played back for about 5 seconds and then stops automatically.
CANCEL	Select to stop the END SEARCH function.

SEARCH

▷ON	Select when you want to search for a scene, title, etc. using the Cassette Memory (p. 60, 61).
OFF	Select to search without using Cassette Memory.

TITLE





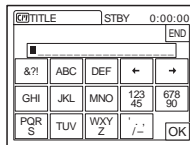

Any titles you have superimposed using this camcorder can only be viewed on a Mini DV video cassette device with the index titler function. If you superimpose a title, you will be able to search for it using Title search. You can superimpose up to about 20 titles (about 5 letters per title) on a cassette with Cassette Memory. Note, however, that only 11 titles can be recorded when other data (6 date/time data/1 cassette label) is recorded.

- 1 Select a desired title from the displayed titles (2 original titles that you have created before and the preset titles that have been stored in your camcorder). You can create original titles (up to 2 types of title of within 20 characters each) in the following procedure.**
 - 1 Select [CUSTOM 1 " "] or [CUSTOM 2 " "] using  / , then touch .**
 - 2 Touch the button repeatedly to select the desired character on the button.**



To erase a character: Touch .

To insert a space: Touch .

- ③ Touch  to move  to select the next character, and enter the character in the same manner.
 - ④ When you have finished entering characters, touch .
 - 2 Touch .
 - 3 Touch  (color),  (position), [SIZE] as necessary to select a desired color, position or size.
- Color**
white → yellow → violet → red → cyan → green → blue
- Position**
You can select from 8 to 9 choices.
- Size**
small ↔ large
(You can only select the small size when you are entering more than 13 characters.)
- 4 Touch .
 - 5 Touch [SAVE].

During playback, playback pause, or recording

[TITLE SAVE] is displayed on the screen for about 5 seconds and the title is set.

During recording standby

[TITLE] appears. When you press REC START/STOP to start recording, [TITLE SAVE] is displayed on the screen for about 5 seconds, and the title is set.



⚡ Notes

- The point you superimposed the title may be detected as an index signal when searching a recording with other video device.
- When you are using your camcorder on the battery pack and do not operate it for 5 minutes, the power automatically goes off as the default setting. If you may take 5 minutes or longer to enter characters, set [A.SHUT OFF] on the  (STANDARD SET) menu to [NEVER] (p. 87). The power will not be turned off. Even though the power goes off, the characters you have entered remain stored in memory. Turn the power back on, then start again from step 1 to continue superimposing the title.

💡 Tip

- To change a created title, select the title in step 1, then touch . Then, reselect the characters again.

TITL ERASE

- 1 Select the title that you want to delete using , then touch .
- 2 Confirm the title is the one you want to erase, then touch [YES].
To cancel the operation, touch [NO].
- 3 Touch .

→ continued

TITLE DISP

You can view the title when you play back the picture.

▷ON	Select to display the title when a scene superimposed with a title appears.
OFF	Select when you do not want to display the title.

TAPE TITLE



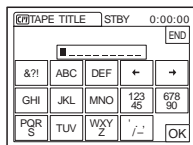

You can label a cassette with Cassette Memory (up to 10 letters). The label will be displayed for approximately 5 seconds when you select the CAMERA-TAPE mode and insert a cassette, or when you select the PLAY/EDIT mode. Up to 4 titles will be displayed at the same time if the cassette has titles superimposed.

- 1 Touch the button repeatedly to select the desired character on the button.





To erase a character: Touch .

To insert a space: Touch .

- 2 Touch  to move  to select the next character, and enter the character in the same manner.
- 3 When you have finished entering characters, touch .
- 4 Touch .

Tips

- To erase the label you have created, touch  repeatedly to erase the characters, then touch .
- To change the label you have created, insert the cassette into your camcorder and go through the procedure from step 1.

ALL ERASE

You can delete all data such as date, title, and cassette label saved in the Cassette Memory at one time.

- 1 Touch **[YES]** twice.
To cancel deletion of all data, select **[NO]**.
- 2 Touch .

Using the (STANDARD SET)

menu –  REC MODE/MULTI-SOUND/AUDIO MIX/USB-CAMERA, etc.

You can select the items listed below on the STANDARD SET menu. To select these items, see “Selecting menu items” (p. 62).

The default settings are marked with ▷. The indicators in parentheses appear when the setting is selected. The settings you can adjust vary depending on the power mode of your camcorder. The screen shows the items you can currently operate. Unavailable items will be grayed out.

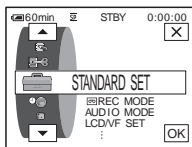

REC MODE

▷SP (<u>SP</u>)	Select to record in the SP (Standard Play) mode on a cassette.
LP (<u>LP</u>)	Select to increase the recording time to 1.5 times the SP mode (Long Play). The use of Sony Excellence/Master mini DV cassette is recommended to get the most out of your camcorder.

Notes

- You cannot add sound on the tape recorded in the LP mode.
- If you record in the LP mode, a mosaic-like noise may appear or sound may be interrupted when you play back the tape on other camcorders or VCRs.
- When you mix recordings in the SP mode and in the LP mode on one tape, the playback picture may be distorted or the time code may not be written properly between the scenes.

AUDIO MODE

▷12BIT	Select to record in the 12-bit mode (2 stereo sounds).
16BIT (<u>16b</u>)	Select to record in the 16-bit mode (1 stereo sound with high quality).

VOLUME

See page 49, 52 for details.

MULTI-SOUND

You can select how to play back audio recorded on a tape in stereo mode.

▷STEREO	Select to play back a stereo tape or dual sound track tape with main and sub sound.
1	Select to play back a stereo tape with the left channel sound or a dual sound track tape with main sound.
2	Select to play back a stereo tape with the right channel sound or a dual sound track tape with sub sound.

🔌 Notes

- You can play back a dual sound track cassette on this camcorder. However, you cannot record a dual sound track on this camcorder.
- The setting returns to [STEREO] when you disconnect the power source from your camcorder for more than 5 minutes.

AUDIO MIX

You can adjust the audio balance between the originally recorded sound (ST1) and sound added afterwards (ST2) on the tape (p. 106).

🔌 Notes

- You cannot adjust sound recorded in 16 bit audio mode.
- Only the originally recorded sound will be heard when you disconnect the power source from your camcorder for more than 5 minutes.

LCD/VF SET

The recorded picture will not be affected by this setting.

LCD BRIGHT

See page 20 for details.

LCD BL LEVEL



You can adjust the brightness of the LCD screen's backlight.

▷NORMAL	Standard brightness.
BRIGHT	Select to brighten the LCD screen.

🔌 Notes

- When you connect your camcorder to outside power sources, [BRIGHT] is automatically selected for the setting.
- When you select [BRIGHT], battery life is reduced by about 10 percent during recording.

LCD COLOR

Touch / to adjust the color on the LCD screen.



VF B.LIGHT

You can adjust the brightness of the viewfinder.

▷NORMAL	Standard brightness.
BRIGHT	To brighten the viewfinder screen.

Notes

- When you connect your camcorder to outside power sources, [BRIGHT] is automatically selected for the setting.
- When you select [BRIGHT], battery life is reduced by about 10 percent during recording.

A/V → DV OUT

You can connect a digital device and an analog device to your camcorder and convert the signal transmitted from the connected devices to the appropriate signal on your camcorder.

▷OFF	Select when not using the Digital convert function.
ON ( /▷DV)	To output analog images and sound in digital format using your camcorder. The analog signal input to the A/V jack of your camcorder will be converted and output from the DV Interface of your camcorder. For details, refer to the “Computer Applications Guide.”

VIDEO INPUT

When you connect your camcorder to another device using the supplied A/V connecting cable, set the type of plug you are going to use for the connection.

▷ VIDEO	Select to input a video signal.
S VIDEO	Select to input an S video signal.

USB-CAMERA

You can connect a USB cable (supplied) to your camcorder, and view the picture displayed on the screen of your camcorder on your computer (USB Streaming). For details, refer to the “Computer Applications Guide.”

▷OFF	Select to deactivate the USB Streaming function.
USB STREAM	Select to activate the USB Streaming function.

→ continued

USB-PLY/EDT

You can connect a USB cable (supplied) to your camcorder, and view the picture on the tape or “Memory Stick Duo” in your camcorder on your computer. For details, refer to the “Computer Applications Guide.”

▷STD-USB	Select to view the picture on the “Memory Stick Duo.”
PictBridge	Select to connect the PictBridge compliant printer (p. 109).
USB STREAM	Select to view the picture on the tape.

DATA CODE

▷OFF	Select not to display date, time and the camera settings data during playback.
DATE/TIME	Select to display the date and time during playback (p. 57).
CAMERA DATA	Select to display the camera settings data during playback (p. 57).

REMAINING

▷AUTO	Select to display the remaining tape indicator for about 8 seconds: <ul style="list-style-type: none">• After you select the CAMERA-TAPE mode with the cassette inserted, and your camcorder calculates the remaining amount of tape.• When you touch  (play/pause).
ON	Select to always display the remaining tape indicator.

REMOTE CTRL

▷ON	Select when using the Remote Commander supplied with your camcorder.
OFF	Select to deactivate the Remote Commander to prevent your camcorder from responding to a command sent by another VCR remote control unit.

Note

- The setting returns to [ON] when you have the power source disconnected from your camcorder for more than 5 minutes.

REC LED

▷ON	Select to turn on the camera recording lamp on the front of your camcorder during recording.
-----	--

OFF	Select this setting in the following recording situations. The camera recording lamp will not light up during recording. <ul style="list-style-type: none"> • When you do not want the subject to be nervous about being recorded. • When you are recording close to the subject. • When the subject reflects the recording lamp.
-----	--

BEEP

▷MELODY	Select to sound a melody when you start/stop recording, operate the touch panel, or when an unusual condition occurs on your camcorder.
NORMAL	Select to sound a beep instead of the melody.
OFF	Select to cancel the melody, the beep sound, the shutter sound or touch panel operation confirmation beep.



DISPLAY



▷LCD PANEL	Select to show the displays such as the time code on the LCD screen and in the viewfinder.
V-OUT/PANEL	Select to show the displays such as the time code on the TV screen, LCD screen, and in the viewfinder.

Note

- You cannot input a signal to your camcorder if you press DSPL/BATT INFO while [V-OUT/PANEL] is selected.

MENU ROTATE

You can select the scrolling direction (up or down) of the menu items on the LCD screen when you touch  or .

▷NORMAL	Select to scroll the menu items downwards by touching  .
OPPOSITE	Select to scroll the menu items upwards by touching  .

A.SHUT OFF

▷5 min	Select to activate the Auto shut off. When approximately 5 minutes have elapsed while you do not operate your camcorder, the camcorder is automatically turned off to prevent the battery from becoming consumed.
NEVER	Select to deactivate the Auto shut off.

Note

- When you connect your camcorder to the wall outlet, [A.SHUT OFF] is automatically set to [NEVER].

Using the (TIME/ LANGU.) menu – CLOCK SET/ WORLD TIME, etc.

You can select items listed below on the TIME/
LANGU. menu. To select items, see “Selecting
menu items” (p. 62).

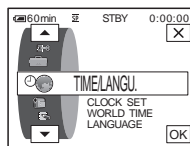

The settings you can adjust vary depending
on the power mode of your camcorder. The
screen shows the items you can currently
operate. Unavailable items will be grayed out.



CLOCK SET

You can set the date and time (p. 22).

WORLD TIME

You can adjust the time difference when using your camcorder abroad. Set the
time difference by touching  / , the clock will be adjusted in accordance
with the time difference. If you set the time difference to 0, the clock returns to
the originally set time.

LANGUAGE

You can select or change the language used for the on-screen display (p. 25). You
can select from English, Simplified English, Canadian-French, Latin American
Spanish, Brazilian-Portuguese, Traditional-Chinese, or Korean.

Customizing Personal Menu

You can add frequently used menu items to Personal Menu, or sort them in the order you like (customizing). You can customize the Personal Menu for each power mode of your camcorder.

Adding a menu – Add

You can add frequently used menu items to Personal Menu for easier and faster access.

Note

- You can add up to 28 menu items each for the CAMERA-TAPE, CAMERA-MEMORY, and PLAY/EDIT modes. If you want to add more, you must delete a less important menu item before adding a new menu item (p. 90).

1 Touch [P-MENU].

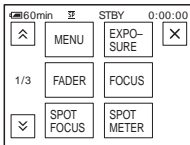

2 Touch [P-MENU SET UP].

If the desired menu is not displayed on the screen, touch / until the menu is displayed.

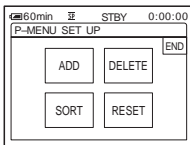

3 Touch [ADD].

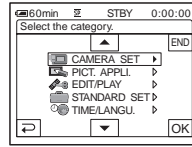

4 Touch / to select a menu category, then touch [OK].

The available items vary depending on the power mode of the camcorder. Only the available items are displayed.

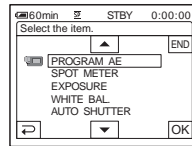

5 Touch / to select a menu item, then touch [OK].

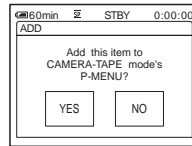

6 Touch [YES].

The menu is added to the end of the list.

7 Touch [X].

→ continued

Deleting menu – Delete

1 Touch [P-MENU].

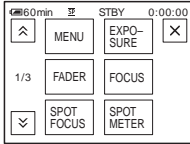

2 Touch [P-MENU SET UP].

If the desired menu is not displayed on the screen, touch / until the menu is displayed.

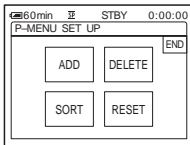

3 Touch [DELETE].

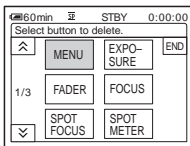

4 Touch the menu that you want to delete.

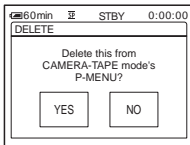

5 Touch [YES].

The selected menu is deleted from Personal Menu.

6 Touch .

Note

- You cannot delete [MENU] and [P-MENU SET UP].

Arranging the order of menus displayed on Personal Menu – Sort

You can sort the menus added to Personal Menu in the desired order.

1 Touch [P-MENU].

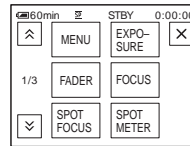

2 Touch [P-MENU SET UP].

If the menu is not displayed on the screen, touch / until the desired menu is displayed.

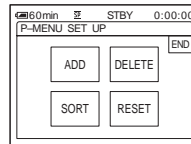

3 Touch [SORT].

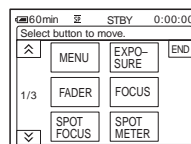

- 4 Touch the menu item you want to move.

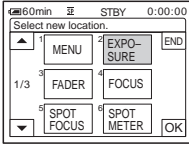

- 5 Touch \uparrow / \downarrow to move the menu item to the desired place.

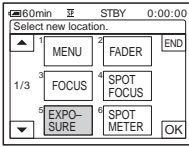

- 6 Touch [OK].

To sort more items, repeat steps 4 to 6.

- 7 Touch [END].

- 8 Touch [X].

Note

- You cannot move [P-MENU SET UP].

Initializing the settings – Reset

You can initialize Personal Menu to the default settings after adding or deleting menus.

- 1 Touch [P-MENU].

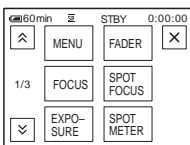

- 2 Touch [P-MENU SET UP].

If the desired menu is not displayed on the screen, touch \uparrow / \downarrow until the menu is displayed.

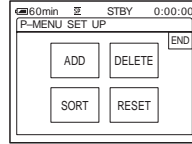

- 3 Touch [RESET].

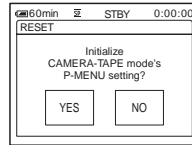

- 4 Touch [YES].

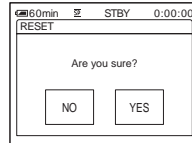

- 5 Touch [YES].

The Personal Menu settings return to the default settings.

To cancel reset, touch [NO].

- 6 Touch [X].

Connecting to a VCR or TV

You can record the picture from a VCR or TV to a tape or a “Memory Stick Duo” inserted into your camcorder (p. 94). You can also create a copy of the picture recorded on your camcorder on other recording device (p. 93). Connect your camcorder to a TV or VCR as shown in the following illustration. Connect your camcorder to the wall outlet using the supplied AC Adaptor during the operation.

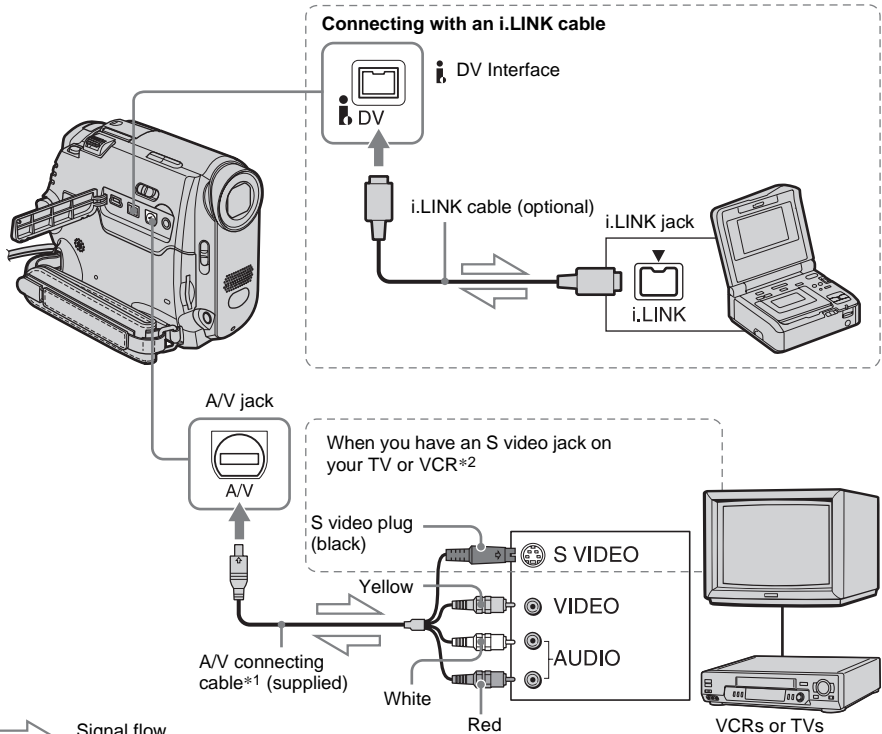

- *1 The supplied A/V connecting cable has a video plug and an S video plug for the video connection.
- *2 This connection produces higher quality DV format pictures. When there is an S video jack on the device to be connected, connect the S video plug to that jack instead of using the yellow video plug. The audio will not be output when you connect with the S video plug alone.

Notes

- Use the A/V connecting cable (supplied) to connect your camcorder to other devices. Before connecting, make sure the [DISPLAY] setting in the (STANDARD SET) menu is set to [LCD PANEL] (the default setting) (p. 87).

- Connect the A/V connecting cable to the output jack of a device you are dubbing a picture from, or to the input jack of another device for dubbing a picture from your camcorder.
- When you are connecting your camcorder to a monaural device, connect the yellow plug of the A/V connecting cable to the video jack, and the red (right channel) or the white (left channel) plug to the audio jack on the VCR or the TV.

To use an i.LINK cable for connection

Use an i.LINK cable (optional) to connect your camcorder to other device via the DV Interface. The video and sound signals are

transmitted digitally, producing high quality pictures. Note that you cannot record the picture and sound separately. For details, see page 130.

Dubbing to another tape

You can copy and edit the picture played back on your camcorder to other recording devices (such as VCRs).

1 Connect your VCR to your camcorder as a recording device (p. 92).

2 Prepare your VCR for recording.

- Insert a cassette for recording.
- If your VCR has an input selector, set it to the input mode.

3 Prepare your camcorder for playback.



- Insert the recorded cassette.
- Slide the POWER switch to select the PLAY/EDIT mode.

4 Start the playback on your camcorder, and record it on the VCR.

Refer to the operating instructions supplied with your VCR for details.

5 When the dubbing is finished, stop your camcorder and the VCR.

Notes

- When your camcorder is connected to the VCR via the  DV Interface, you cannot record the title, indicators, information for the Cassette Memory, and words entered on the index screen of the “Memory Stick Duo.”
- When dubbing using the A/V connecting cable, press DSPL/BATT INFO to hide indicators such as time code (p. 57). Otherwise, they will be recorded on the tape.
- To record the date/time and camera settings data, have them displayed on screen (p. 57).
- Pictures edited with Picture effect ([PICT. EFFECT] p. 74), Digital effect (p. 43, 51), or Playback zoom (p. 56) cannot be output via the  DV Interface.
- When connected using the i.LINK cable, the recorded picture becomes rough when a picture is paused on your camcorder while recording to a VCR.

Recording pictures from a VCR or TV

You can record and edit pictures or TV programs from a VCR or TV on a tape or a “Memory Stick Duo” inserted in your camcorder. You can also record a scene as a still image on a “Memory Stick Duo.”

Insert a cassette or a “Memory Stick Duo” for recording in your camcorder. If you have connected the A/V connecting cable, select the input signal in [VIDEO INPUT] in the  (STANDARD SET) menu (p. 85)

Recording movies





-
- 1 **Connect your TV or VCR to your camcorder (p. 92).**

 - 2 **If you are recording from a VCR, insert a cassette.**



 - 3 **Slide the POWER switch to select the PLAY/EDIT mode.**

 - 4 **Operate your camcorder to record movies.**

When recording on a tape

- 1 Touch .
- 2 Touch  [REC CTRL].
If the item is not displayed on the screen, touch /[]. If you cannot find it, touch [MENU], and select it from the  (EDIT/PLAY) menu (p. 79).
- 3 Touch [REC PAUSE].

When recording on a “Memory Stick Duo”

- 1 Touch .
- 2 Touch [MENU].
- 3 Select the  (EDIT/PLAY) menu, then  [REC CTRL].

-
- 5 **Start playing the cassette on your VCR, or select a TV program.**

The picture played on the connected device appears on the LCD screen of your camcorder.

-
- 6 **Touch [REC START] at the point you want to start recording.**

-
- 7 **Stop recording.**

When recording on a tape

Touch  (stop) or [REC PAUSE].

When recording on a “Memory Stick Duo”

Touch [REC STOP].

-
- 8 **Touch , then .**
-

Tips

- The **DV IN** indicator appears when you connect your camcorder and other devices via an i.LINK cable. (This indicator may also appear on your TV.)
- When recording movies on a “Memory Stick Duo,” you can skip step 4 and press REC START/STOP in step 6.

Recording still images

-
- 1 **Perform steps 1 to 3 in “Recording movies” (p. 94).**

-
- 2 **Play the video, or receive the TV program you want to record.**

The pictures on the VCR or TV appear on the screen of your camcorder.

- 3 Press **PHOTO** lightly at the scene you want to record. Check the image and press it fully.

The image is not recorded unless you press **PHOTO** fully. Release it if you do not want to record the scene, and select other scene as described above.

Dubbing pictures from a tape to a “Memory Stick Duo”

You can record movies (with sound recorded in monaural) or still images on a “Memory Stick Duo.”

Make sure you have a recorded tape and a “Memory Stick Duo” inserted into your camcorder.

- 1 Slide the **POWER** switch to select the **PLAY/EDIT** mode.



- 2 Search and record the scene you want to record.

When recording a still image

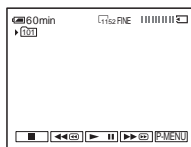
- 1 Touch  (play) to play back the tape.
- 2 Press **PHOTO** lightly at the scene you want to record. Check the image and press it fully.



When recording a movie

- 1 Touch **P-MENU**.
- 2 Touch **[MENU]**.
- 3 Select the  (EDIT/PLAY) menu, then **[REC CTRL]**.
- 4 Touch  (play) to play back the tape.

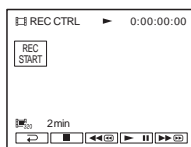

- 5 Touch **[REC START]** at the point you want to start recording.
- 6 Touch **[REC STOP]** at the point you want to stop recording.
- 7 Touch  (stop) to stop tape playback.

→ *continued*

8 Touch , then .

Notes













- DCR-HC40:
You can record still images fixed to image size [640 × 480].
- The Data code and titles recorded on the tape cannot be recorded on the “Memory Stick Duo.” The time and date the picture is recorded on the “Memory Stick Duo” will be recorded.
- The sound is recorded in 32kHz monaural.

Tips

- You can also record a movie by pressing REC START/STOP during tape playback.
- For the recording time of movies, see page 28.

Dubbing still images from a “Memory Stick Duo” to a tape

You can record still images on a tape. Make sure you have the “Memory Stick Duo” with the images and a tape inserted into your camcorder.

- 1 Slide the **POWER** switch to select the **PLAY/EDIT** mode.
- 2 Search for the point where you want to start dubbing by touching  (rewind) or  (fast forward), then touch  (stop).
- 3 Touch  **[PB]**.
- 4 Touch  (previous)/ (next) to select the image you want to dub.
- 5 Touch **[P-MENU]**.
- 6 Touch  **[REC CTRL]**.
If the item is not displayed on the screen, touch /. If you cannot find it, touch **[MENU]**, and select it from the  (EDIT/PLAY) menu.
- 7 Touch **[REC PAUSE]**.
- 8 Touch **[REC START]**.
The selected image is dubbed to the tape.
- 9 Touch  (stop) or **[REC PAUSE]** when you want to stop recording.
To dub other still images, select images by touching /, then repeat steps 7 to 9.

10 Touch [⏪], then [X].

⚡ Notes

- You cannot dub the index screen.
- You may not be able to dub images modified on your computer or recorded with other camcorders on your camcorder.
- You cannot dub MPEG movies on the tape.

Dubbing selected scenes from a tape

– Digital program editing

You can select up to 20 scenes (programs) and record them in the desired order to other recording device such as VCRs or to a “Memory Stick Duo” inserted in your camcorder.

When you are recording on a “Memory Stick Duo,” skip steps 1 and 2 and start from “Recording the selected scenes as programs” (p. 101).

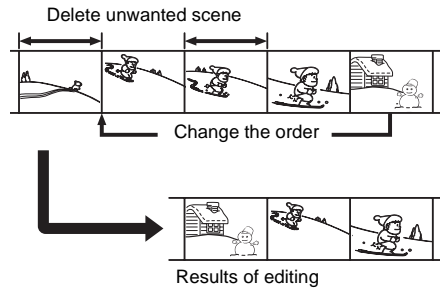

Step 1 [100]: Preparing your camcorder and VCR for operation

Follow the steps below when you are performing a digital program edit for the first time to a tape in a VCR. You can skip this setting if you have set up the VCR by the following procedure before.

⚡ Notes

- You cannot perform the Digital program editing on a VCR that does not support [IR SETUP] codes.
- The operating signal for the Digital program editing cannot be transferred via the LANC jack.

1 Connect your VCR to the camcorder as a recording device (p. 92).

You can use either the A/V connecting cable or the i.LINK cable to make the

→ continued

connection. The dubbing procedure is easier with the i.LINK connection.

2 Prepare your VCR.

- Insert a cassette for recording.
- Set the input selector to input mode if your VCR has one.

3 Prepare your camcorder (playing device).

- Insert a cassette for editing.
- Slide the POWER switch to select the PLAY/EDIT mode.

4 Touch [P-MENU].

5 Touch [MENU].

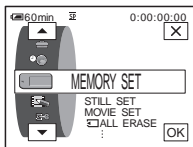

6 Touch / to select (EDIT/PLAY), then touch [OK].

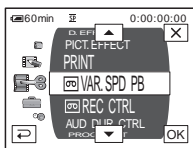

7 Touch / to select [PROG. EDIT], then touch [OK].

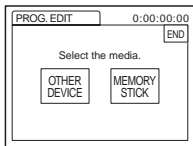

8 Touch [OTHER DEVICE].

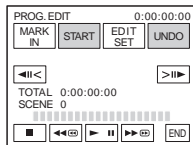

9 Touch [EDIT SET].

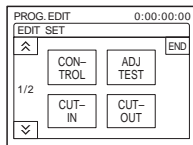

10 Touch [CONTROL].

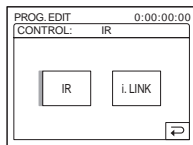

11 Select [IR] or [i.LINK].

When connecting with an A/V connecting cable

Touch [IR], then [OK]. Follow the procedure described in “To set the [IR SETUP] code” (p. 99).

When connecting with an i.LINK cable

Touch [i.LINK], then [OK]. Go on to “Step 2 : Adjusting the synchronization of the VCR” (p. 100).

To set the [IR SETUP] code

When you connect with an A/V connecting cable, you need to check the [IR SETUP] code signal to see if your VCR can be operated by your camcorder (infrared ray emitter).

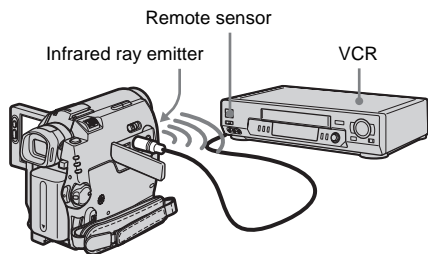

- 1 Touch ∇ , then [IR SETUP].**
- 2 Select the [IR SETUP] code of your VCR with \ominus / \oplus , then touch [OK].**
For the [IR SETUP] code of your VCR, refer to "[IR SETUP] code list" (p. 99).
When there is more than one code listed for the manufacturer of your VCR, try each code and find the most appropriate one.
- 3 Touch [PAUSEMODE].**
- 4 Select the mode to cancel recording pause on the VCR, then touch [OK].**
Refer to the operating instructions supplied with your VCR for details on operation.
- 5 Point the infrared ray emitter of your camcorder towards the remote sensor on your VCR, from about 30 cm (12 in.) away, with no obstructions.**
- 6 Insert a cassette into your VCR, and set the VCR to recording pause.**
- 7 Touch [IR TEST].**
- 8 Touch [EXEC].**
The recording starts on your VCR when the setting is correct. [Completed.] appears when the [IR SETUP] code test is finished. Go on to "Step 2 : Adjusting the synchronization of the VCR" (p. 100).
When recording fails to start, select another [IR SETUP] code and try again.

[IR SETUP] code list

The following [IR SETUP] codes are recorded on your camcorder by default. (It is set at "3" as the default setting.)

Manufacturing company	[IR SETUP] code
Sony	1, 2, 3, 4, 5, 6
Admiral (M. Wards)	89
Aiwa	47, 54, 80
Akai	49, 51
Audio Dynamic	21, 35
Bell&Howell (M. Wards)	36
Broksonic	21, 70, 82
Canon	77, 78
Citizen	47
Craig	47, 73
Curtis Mathis	8, 77, 80
Daewoo	26, 40, 77
DBX	21, 33, 35
Dimensia	8
Emerson	26, 48, 59, 70, 80, 81, 82
Fisher	36, 37, 44, 45
Funai	80
General Electric	8, 32*, 77, 94*, 101
Goldstar/LG	47
GO VIDEO	71
Hitachi	8, 42, 78
HQ	40
Instant Replay	77, 78
JC Penny	8, 21, 33, 35, 36, 42, 77
JVC	12, 13, 14, 21, 33, 35
Kenwood	21, 33, 35, 47
LXI (Sears)	36, 37, 42, 44, 45, 47, 49, 80
Magnavox	17, 77, 78, 83
Marantz	21, 33, 35
Marta	47
Memorex	37, 77
Minolta	8, 42
Mitsubishi/MGA	22, 23, 24, 28, 29

→ continued

Manufacturing company	[IR SETUP] code
Multitech	23, 32, 80
NEC	21, 33, 35
Olympic	77, 78
Optimus	22
Orion	60
Panasonic	16, 17, 77, 78
Pentax	8, 42
Philco	26, 70, 77, 78
Philips	47, 77, 78, 83
Pioneer	78
Quasar	6, 16, 17, 77, 78
RCA/PROSCAN	7, 8, 16, 40, 41, 42, 77, 78, 78*, 83, 101
Realistic	22, 36, 37, 77, 80, 88
Sansui	21
Singer	73
Samsung	24, 24*, 32, 32*, 41, 94, 94*
Sanyo	26, 36, 37, 47
Scott	22, 23, 24, 28, 32, 37, 40, 41
Sharp	88, 89
Shintom	73
Signature 2000	80, 89
Sylvania	77, 78, 80, 83
Symphonic	80
Tashiro	47
Tatung	21, 33, 35
Teac	21, 33, 35, 80
Technics	77, 78
Toshiba	7, 40, 49
Wards	37, 47, 88, 89, 95
Yamaha	21, 33, 35, 36
Zenith	95

* TV/VCR component

Step 2 : Adjusting the synchronization of the VCR

Follow the steps below when you are performing digital program edit for the first time to a tape in a VCR. You can skip this setting if you have set up your VCR before using the following procedure. You can adjust the synchronization of your camcorder and the VCR to avoid not recording the starting scene.

- 1 **Remove the cassette from your camcorder. Prepare a pen and paper to take notes.**
- 2 **Set the VCR to recording pause mode.** Skip this step if you have selected [i.LINK] in step 11 on p. 98.

Note

- Run the tape for about 10 seconds before pausing. The starting scenes may not get recorded when you start recording from the beginning of the tape.

- 3 **Touch , then [ADJ TEST].**

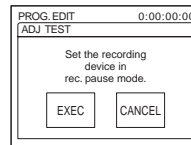

- 4 **Touch [EXEC].**

A picture (about 50 seconds long) with 5 [IN] and [OUT] indicators each for adjusting synchronization is recorded. [Completed.] appears when the recording is finished.

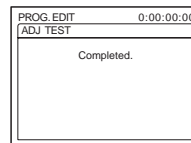

- 5 **Rewind the tape on your VCR, then play back in slow mode.**

5 opening numbers for each [IN] and closing numbers for each [OUT] appear.

- 6 **Take a note of the opening number value of each [CUT-IN] and the closing number value of each [CUT-OUT], then calculate the average number value for each [CUT-IN] and [CUT-OUT].**

- 7 **Touch [CUT-IN].**

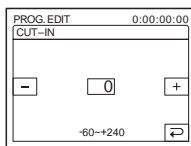

- 8 **Touch \ominus/\oplus to select the average number value for [CUT-IN], then touch [OK].**

The calculated start position for recording is set.

- 9 **Touch [CUT-OUT].**

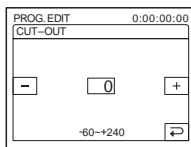

- 10 **Touch \ominus/\oplus to select the average number value for [CUT-OUT], then touch [OK].**

The calculated stop position for recording is set.

- 11 **Touch [END] twice.**

Recording the selected scenes as programs

When you are performing a digital program edit for the first time to a tape in a VCR, go through the procedures described in Steps 1 and 2 (p. 97 to p. 100) beforehand.

- 1 **Prepare a cassette or a “Memory Stick Duo.”**

Insert a tape to be played back into the camcorder.

When you are recording on a tape, insert a cassette for recording into your VCR. When you are recording on a “Memory Stick Duo,” insert a “Memory Stick Duo” into your camcorder.

- 2 **Touch [P-MENU].**

- 3 **Touch [MENU].**

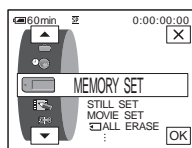

- 4 **Touch \uparrow/\downarrow to select EDIT/PLAY , then touch [OK].**

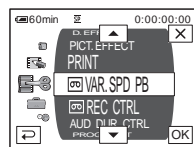

- 5 **Touch \uparrow/\downarrow to select [PROG. EDIT], then touch [OK].**

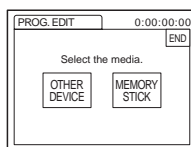

→ continued

6 Touch the desired item.

When you are recording on a tape in the VCR

Touch [OTHER DEVICE].

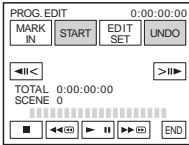

When you are recording on a "Memory Stick Duo"

1 Touch [MEMORY STICK].

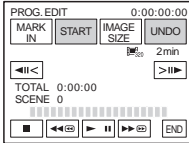

2 Touch [IMAGE SIZE] repeatedly to select the desired image size.

7 Search for the beginning of the first scene that you want to dub on your camcorder, then pause playback.

You can adjust the position with / (frame).

8 Touch [MARK IN].

The starting point of the first program is set, and the upper part of the program mark changes to light blue.

[IMAGE SIZE] appears when recording on a "Memory Stick Duo."

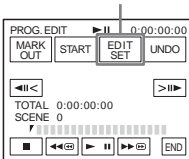

9 Search for the end of the first scene that you want to record on your camcorder, then pause playback.

You can adjust the position with / (frame).

10 Touch [MARK OUT].

The ending point of the first program is set, and the lower part of the program mark changes to light blue.

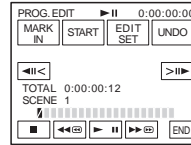

11 Repeat steps 7 to 10 and create programs.

12 Set your VCR to recording pause.

Skip this step if your camcorder is connected via an i.LINK cable or recording on a "Memory Stick Duo."

13 Touch [START].

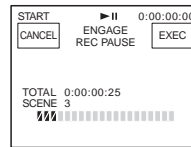

14 Touch [EXEC].

A search for the beginning of the first program starts, then the recording starts. [SEARCH] appears during the search and [EDITING] appears during editing.

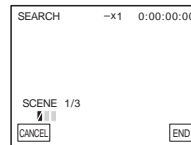

When a program is recorded, the program mark changes from orange to light blue. When all programs have been recorded, the program editing operation stops automatically.

To cancel recording, touch [CANCEL].

To end Digital program editing

Touch [END].

To save a program without using it to record

Touch [END] in step 11.

The program is stored in memory until the cassette is ejected.

To erase programs

- 1 Follow steps 1 to 6 in “Recording the selected scenes as programs” (p. 101), then touch [UNDO].**
- 2 Touch [DEL 1MARK] to delete the last set program. Or, touch [ALL ERASE] to erase all the programs.**
- 3 Touch [EXEC].**
The programs are deleted.
To cancel this operation, touch [CANCEL].

Notes

- You cannot set starting point or ending point on a blank section of the tape. If there is a blank section between the starting and ending point of the program, the total time may not appear correctly.
- When you cannot operate the device correctly using an i.LINK cable connection, select [IR] in step 11 on p. 98, and set the [IR SETUP] code.

Dubbing sound to a recorded tape

You can record additional audio to the original sound on the tape. You can add sound to a tape already recorded in the 12-bit mode without erasing the original sound.

Preparing for audio recording

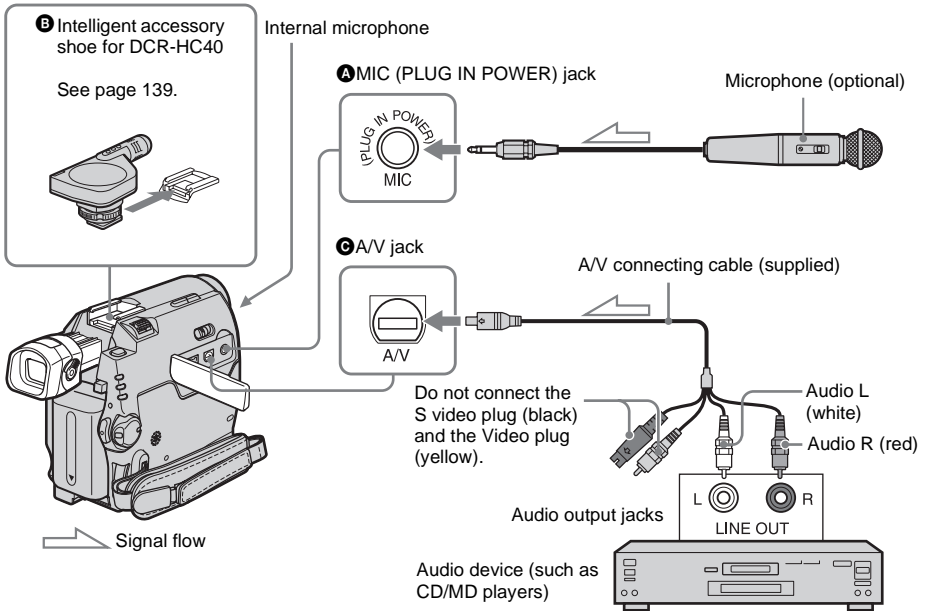

Record audio in one of the following ways.

- Using the internal microphone (no connection required).
- Connecting a microphone (optional) to the MIC jack. **(A)**
- Connecting a microphone (optional) to the Intelligent accessory shoe for DCR-HC40. **(B)**
- Connecting audio device to your camcorder using an A/V connecting cable. **(C)**









The audio input to be recorded takes precedence over others in the order of MIC jack → Intelligent accessory shoe for DCR-HC40 → A/V jack → internal microphone.

Notes

- You cannot record additional audio:
 - When the tape is recorded in the 16-bit mode.
 - When the tape is recorded in the LP mode.
 - When your camcorder is connected via the i.LINK cable.
 - On blank sections of the tape.
 - When the write-protect tab of the cassette is set to SAVE.
- When you are using the A/V jack or the internal microphone to record additional sound, the picture will not be output from the S VIDEO jack or the A/V jack. Check the picture on the LCD screen or the viewfinder.
- When you use an external microphone (optional) to record additional audio, you can check the picture and the sound by connecting your camcorder to a TV using the A/V connecting cable. However, the sound

you have recorded afterwards is not output from the speaker. Check the sound by using a TV.

Recording sound

- 1 Insert a recorded cassette into your camcorder.
- 2 Slide the POWER switch repeatedly to select the PLAY/EDIT mode.
- 3 Touch  (play/pause) to play the tape.
- 4 Touch  (play/pause) again at the point where you want to start recording the sound.
The playback pauses.
- 5 Touch  [P-MENU].
- 6 Touch  [MENU].
- 7 Touch  to select  (EDIT/PLAY), then touch  [OK].
- 8 Touch  to select [AUD DUB CTRL], then touch  [OK].

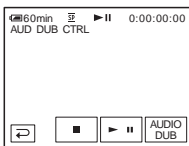

9 Touch [AUDIO DUB].

A green  mark appears on the LCD screen.

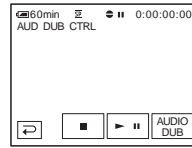

10 Touch (play) and start playing back the audio you want to record at the same time.

A red  mark remains on the LCD screen while recording sound.
The new sound is recorded in stereo 2 (ST2) during the playback of the tape.

11 Touch (stop) when you want to stop recording.

To dub on other scenes, repeat steps 3 and 4 to select scenes, then touch [AUDIO DUB].

12 Touch , then .

To set the end point for audio dubbing

During playback, press ZERO SET MEMORY on the Remote Commander at the scene at which you want to stop audio dubbing. Then, perform steps 4 to 10. The recording stops automatically at the selected scene.

Note

- You can only record additional audio over a tape recorded on your camcorder. The sound may deteriorate when you dub audio on a tape recorded on other camcorders (including other DCR-HC30/HC40 camcorders).

Checking and adjusting the recorded sound

1 Play back the tape on which you have recorded audio in “Recording sound” (p. 105).

2 Touch [P-MENU].

3 Touch [MENU].

4 Touch / to select (STANDARD SET), then touch .

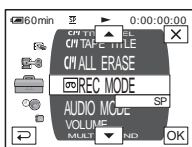

5 Touch / to select [AUDIO MIX], then touch .

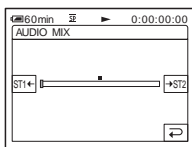

6 Touch /[ST1] / /[ST2] to adjust the balance between the original sound (ST1) and the sound recorded afterwards (ST2). Then, touch .

The original sound (ST1) is output in the default setting.

The adjusted audio balance returns to the default setting in about 5 minutes after the battery pack or other power sources have been disconnected.

Deleting recorded pictures

You can delete all or selected pictures stored on a “Memory Stick Duo.”

1 Slide the POWER switch repeatedly to select the PLAY/EDIT mode.

2 Touch [PB].

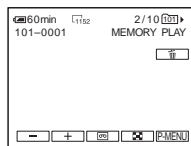

3 Touch (previous)/ (next) to select a picture you want to delete.

4 Touch .

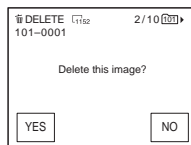

5 Touch [YES].









The selected picture is deleted.
To cancel deletion, touch [NO].

To delete all pictures at once

Select the (MEMORY SET) menu, then [ALL ERASE] (p. 71).

To delete pictures on the index screen

You can easily search for the picture to be deleted by displaying 6 pictures at once.

- 1 Slide the **POWER** switch to select the **PLAY/EDIT** mode.
- 2 Touch .
- 3 Touch .
- 4 Touch .
- 5 Touch [] **DELETE**.
- 6 Touch the picture you want to delete.
 appears on the image to be deleted.
To display the next or the previous 6 pictures, touch /.
- 7 Touch .
- 8 Touch [**YES**].
The selected pictures are deleted.
To cancel deletion, touch [**NO**].

Notes

- Pictures cannot be deleted when you are using a “Memory Stick Duo” with the write-protect tab and the “Memory Stick Duo” is write-protected (p. 127), or when the selected picture is protected (p. 107).
- The pictures cannot be restored once they are deleted. Make sure you check the pictures before deleting them.



Marking recorded images with specific information – Image

protection/Print mark

When you are using a “Memory Stick Duo” with the write-protect tab, make sure the write-protect tab on the “Memory Stick Duo” is not set to the write-protect position.

Preventing accidental erasure – Image protection

You can select and mark images to prevent accidental erasure.

- 1 Slide the **POWER** switch to select the **PLAY/EDIT** mode.
- 2 Touch .
- 3 Touch .

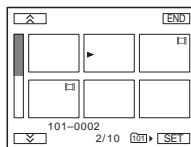

- 4 Touch .

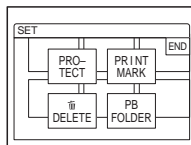

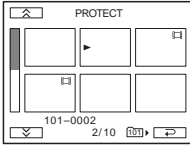

→ continued

5 Touch [PROTECT].

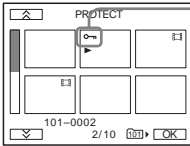

6 Touch the image that you want to protect.



 appears on the selected image.

7 Touch [OK].

8 Touch [END].

To cancel image protection

Follow steps 1 to 5, then touch the image to cancel image protection.

 disappears from the image.

Selecting still images for printing – Print mark

You can mark images that you want to print out while viewing them on your camcorder. (You cannot specify the number of printouts.)

The DPOF (Digital Print Order Format) standard is used to select images for printing on your camcorder.

1 Slide the POWER switch to select the PLAY/EDIT mode.

2 Touch [PB].

3 Touch .

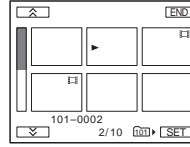

4 Touch [SET].

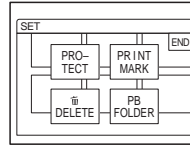

5 Touch [PRINT MARK].

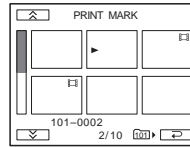

6 Touch the image that you want to print out later.

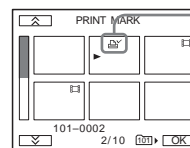

 appears on the selected image.

7 Touch [OK].

8 Touch [END].

To cancel the Print mark

Follow steps 1 to 5, then touch the image to cancel the Print mark.

 disappears from the image.

Note

- Do not mark images on your camcorder if the “Memory Stick Duo” already has some images with the Print mark put on other devices. This may change the information of the images with the Print mark put on the other device.

Printing recorded images (PictBridge compliant printer)

You can easily print still images recorded on your camcorder by using a PictBridge compliant printer, even if you do not have a computer. Just set the connection in the menu setting screen of your camcorder, then connect your camcorder and printer using the USB cable.

PictBridge

Tip

- PictBridge is an industry standard established by the Camera & Imaging Products Association (CIPA). You can print still images without using a computer by connecting a printer directly to a digital video camera or digital still camera, regardless of model manufacturer.





Connect your camcorder to the printer

Note

- Connect the supplied AC Adaptor to the wall outlet for the power supply.

- 1 **Insert the “Memory Stick Duo” on which still images are stored into your camcorder.**
- 2 **Set the paper in the printer, and turn on the power.**
- 3 **Slide the POWER switch repeatedly to select the PLAY/EDIT mode.**
- 4 **Touch .**
- 5 **Touch [MENU].**

→ continued

-
- 6 Select  (STANDARD SET), then [USB-PLY/EDT] by touching / and .
-

- 7 Select [PictBridge], then touch .
-

- 8 Touch .
-

- 9 Connect the USB jack (p. 138) of your camcorder to a printer using the supplied USB cable.

The location of the USB jack of the printer differs depending on the model. Refer to the operating instructions supplied with your printer for details on operation.

- 10 Select  (PICT. APPLI), then [PRINT] by touching / and .

When connection between your camcorder and printer is complete,  appears on the screen.

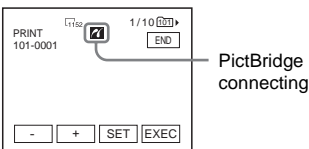



One of the images stored on the “Memory Stick Duo” will be displayed.



Notes

- We cannot guarantee the operation of models that are not PictBridge compatible.
 - You cannot connect your camcorder to the printer if [USB-PLY/EDT] in the menu settings is not set to [PictBridge]. Follow the instructions shown on the screen.
-

Printing

-
- 1 Select the image to be printed by touching  (previous image)/ (next image).
-

- 2 Touch , then [COPIES].
-

- 3 Select the number of copies to be printed by touching /, then touch .

You can set a maximum of 20 copies of one image to be printed.

- 4 Touch [END].

To print the date on the image

- 1 Touch , then [DATE/TIME].

- 2 Select [DATE] or [DAY & TIME] and .

The default setting is [OFF].

- 5 Touch [EXEC].

A confirmation screen appears.

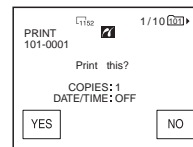

-
- 6 Touch [YES].

When printing is finished, [Printing...] disappears and the image selection screen appears again.

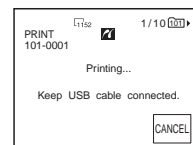

To print another image

Repeat steps 1 to 6.

To stop printing

Touch [CANCEL] while printing.

To finish printing

Touch [END] and disconnect the USB cable from your camcorder and printer.

Notes

- Do not attempt the following operations when  is on the screen. The operations may not be performed properly.
 - Sliding the POWER switch to select other power modes
 - Disconnecting the USB cable from your camcorder or printer
 - Removing the “Memory Stick Duo” from your camcorder
- If the printer stops working, disconnect the USB cable and restart the operation from the beginning.
- Some printer models may not support the date printing function. Refer to your printer’s operating instructions for details.
- We cannot guarantee the printing of images recorded with a device other than your camcorder.

Troubleshooting

If you run into any problem using your camcorder, use the following table to troubleshoot the problem. If the problem

persists, remove the power source and contact your Sony dealer.

If “C:□□:□□” is displayed on the LCD screen or the viewfinder, the self-diagnosis display function is activated. See page 120 for details.

Overall operations

Symptom	Cause and/or Corrective Actions
The power does not turn on.	<ul style="list-style-type: none"> • The battery pack is discharged, running low, or not attached to the camcorder. → Attach a charged battery pack to the camcorder. (p. 16) → Use the AC Adaptor to connect to the wall outlet. (p. 19)
The camcorder does not operate even when the power is set to on.	→ Disconnect the AC Adaptor from the wall outlet or remove the battery pack, then reconnect it after about 1 minute. If the functions still do not work, press the RESET button using a sharp-pointed object. (If you press the RESET button, all settings including the clock setting are reset, except Personal Menu items.)
The supplied Remote Commander does not function.	<ul style="list-style-type: none"> → Set [REMOTE CTRL] on the  (STANDARD SET) menu to [ON]. (p. 86) → Insert a battery into the battery holder with the + – polarities correctly matching the + – marks. If this still does not solve the problem, insert a new battery since the battery is dead. (p. 141) → Remove any obstructions between the Remote Commander and the remote sensor.
The camcorder gets warm.	<ul style="list-style-type: none"> • This is because the power has been turned on for a long time. This is not a malfunction.



Batteries/Power sources

Symptom	Cause and/or Corrective Actions
The CHG (charge) lamp does not light while the battery pack is being charged.	<ul style="list-style-type: none"> → Attach the battery pack to the camcorder correctly. If the lamp still does not light up, then it indicates that no power is supplied from the wall outlet. • The battery charge is completed. (p. 16)
The CHG (charge) lamp flashes while the battery pack is being charged.	<ul style="list-style-type: none"> → Attach the battery pack to the camcorder correctly. If the problem persists, disconnect the AC Adaptor from the wall outlet and contact your Sony dealer. The battery pack may be damaged. (p. 16)
The battery pack is quickly discharged.	<ul style="list-style-type: none"> • The temperature of the environment is too low, or the battery pack has not been charged enough. This is not a malfunction. → Fully charge the battery again. If the problem persists, replace the battery pack with a new one. It may be damaged. (p. 16, 129)
The remaining battery time indicator does not indicate the correct time.	<ul style="list-style-type: none"> • The temperature of the environment is too high or too low, or the battery pack has not been charged enough. This is not a malfunction. → Fully charge the battery again. If the problem persists, replace the battery pack with a new one. It may be damaged. (p. 16, 129)
The power turns off frequently although the remaining battery indicator indicates that the battery pack has enough power to operate.	<ul style="list-style-type: none"> • A problem has occurred in the remaining battery time indicator, or the battery pack has not been charged enough. → Fully charge the battery again to correct the indication. (p. 16)
The power abruptly turns off.	<ul style="list-style-type: none"> • [A.SHUT OFF] in the  (STANDARD SET) menu is set to [5 min]. (p. 87) → When approximately 5 minutes have elapsed while you do not operate your camcorder, the camcorder is automatically turned off. Slide the POWER switch down to turn the power on again. (p. 19) Or use the AC Adaptor.
A problem occurs when the camcorder is connected to the AC Adaptor.	<ul style="list-style-type: none"> → Turn off the power, and disconnect the AC Adaptor from the wall outlet. Then, connect it again.

Cassette tapes

Symptom	Cause and/or Corrective Actions
Cassette cannot be ejected from the compartment.	<ul style="list-style-type: none"> → Make sure the power source (battery pack or AC Adaptor) is connected correctly. (p. 16) → Remove the battery pack from the camcorder, then attach it again. (p. 16) → Attach a charged battery pack to the camcorder. (p. 16)
Cassette is not ejected even when the cassette lid is open.	<ul style="list-style-type: none"> • Moisture condensation is starting in your camcorder. (p. 132)

→ continued





Symptom	Cause and/or Corrective Actions
The Cassette Memory indicator does not appear while using a cassette with Cassette Memory.	→Clean the gold-plated connector of the cassette. (p. 126)
The remaining tape indicator is not displayed.	→Set [ REMAINING] to [ON] on the  (STANDARD SET) menu to always display the remaining tape indicator. (p. 86)
A cassette label is not recorded.	→Use a cassette with Cassette Memory. (p. 125) →Erase unnecessary titles when the Cassette Memory is full. (p. 81) →Set the write-protect tab to REC. (p. 125)

LCD screen/viewfinder

Symptom	Cause and/or Corrective Actions
An unknown language appears on the screen.	→See page 25.
An unknown picture appears on the screen.	<ul style="list-style-type: none"> The camcorder is in [DEMO MODE]. (The [DEMO MODE] is automatically displayed when you leave the camcorder for 10 minutes after selecting CAMERA-TAPE without inserting a cassette and “Memory Stick Duo.”) →Touch on the LCD screen or insert a cassette or “Memory Stick Duo” to cancel [DEMO MODE]. You can also set [DEMO MODE] to [OFF] on the menu. (p. 78)
An unknown indicator appears on the screen.	→Refer to the indicator list. (p. 143)
The buttons do not appear on the touch panel.	→Touch the LCD panel lightly. →Press DSPL/BATT INFO (or DISPLAY on the Remote Commander). (p. 57)
The buttons on the touch panel do not work correctly or do not work at all.	→Adjust the screen ([CALIBRATION]). (p. 133)
The picture in the viewfinder is not clear.	→Extend the viewfinder. (p. 21) →Use the viewfinder lens adjustment lever to adjust the lens. (p. 21)
The picture in the viewfinder has disappeared.	→Close the LCD panel. The picture is not displayed in the viewfinder when the LCD panel is open. (p. 21)
The picture remains on the LCD screen.	<ul style="list-style-type: none"> This occurs if you disconnect the AC Adaptor from the wall outlet or remove the battery pack without turning off the power first. This is not a malfunction.

Recording

If you are using a “Memory Stick Duo” for recording, refer also to the “Memory Stick Duo” section. (p. 117)





Symptom	Cause and/or Corrective Actions
The tape does not start when you press REC START/STOP.	<ul style="list-style-type: none"> →Slide the POWER switch to turn on the CAMERA-TAPE lamp. (p. 19) →The tape has reached the end. Rewind it, or insert a new cassette. →Set the write-protect tab to REC or insert a new cassette. (p. 125) →The tape is stuck to the drum due to moisture condensation. Remove the cassette and leave your camcorder for at least 1 hour, then re-insert the cassette. (p. 132)
The power abruptly turns off.	<ul style="list-style-type: none"> • [A.SHUT OFF] in the  (STANDARD SET) menu is set to [5 min]. (p. 87) <ul style="list-style-type: none"> →When approximately 5 minutes have elapsed while you do not operate your camcorder, the camcorder is automatically turned off. Slide the POWER switch down to turn the power on again. (p. 19) Or use the AC Adaptor. • Charge the battery pack. (p. 16)
The SteadyShot does not function.	<ul style="list-style-type: none"> →Set [STEADYSHOT] to [ON] in the  (CAMERA SET) menu. (p. 69)
The auto focus does not function.	<ul style="list-style-type: none"> →Set [FOCUS] to [AUTO] in the  (CAMERA SET) menu to enable auto focus. (p. 41) →The recording conditions are not suitable for auto focus. Adjust the focus manually. (p. 41)
A vertical band appears when recording candlelight or electric light in the dark.	<ul style="list-style-type: none"> • This occurs when the contrast between the subject and the background is too high. This is not a malfunction.
A vertical band appears when recording a bright subject.	<ul style="list-style-type: none"> • This phenomenon is called the smear effect. This is not a malfunction.
Tiny spots in white, red, blue, or green appear on the screen.	<ul style="list-style-type: none"> • The spots appear when you are recording in [SLOW SHUTTR], Super NightShot plus, or Color Slow Shutter. This is not a malfunction. (p. 39)
The color of the picture is not correctly displayed.	<ul style="list-style-type: none"> →Deactivate the NightShot plus function. (p. 39)
Picture appears too bright on the screen, and the subject does not appear on the screen.	<ul style="list-style-type: none"> →Deactivate the NightShot plus function in bright places. (p. 39) →Cancel the back light function. (p. 37)
Picture appears too dark on the screen, and the subject does not appear on the screen.	<ul style="list-style-type: none"> • The LCD screen backlight is switched off. <ul style="list-style-type: none"> →Press LCD BACKLIGHT. (p. 20)
The shutter sound is not heard.	<ul style="list-style-type: none"> →Set [BEEP] to [MELODY] or [NORMAL] on the  (STANDARD SET) menu. (p. 87)
Black bands appear when you record a TV screen or computer screen.	<ul style="list-style-type: none"> →Set [STEADYSHOT] to [OFF] on the  (CAMERA SET) menu. (p. 69)

→continued

Symptom	Cause and/or Corrective Actions
The external flash (optional) does not work.	<ul style="list-style-type: none"> The power of the flash is not turned on, or the flash is not attached correctly. Two or more flashes are attached. Only one external flash can be attached.
The flash level cannot be changed.	<ul style="list-style-type: none"> The flash level cannot be changed during Easy Handycam operation.
Flickering or changes in color occurs.	→This occurs when recording pictures under a fluorescent lamp, sodium lamp, or mercury lamp in the soft portrait or sports lesson mode. Cancel [PROGRAM AE] in this case. (p. 64)
END SEARCH does not work.	<ul style="list-style-type: none"> The cassette was ejected after recording when using a cassette without Cassette Memory. (p. 125) The cassette is new and has nothing recorded.
END SEARCH does not work correctly.	<ul style="list-style-type: none"> There is a blank section in the beginning or middle of the tape. This is not a malfunction.

Playback

If you are playing back the pictures stored on a “Memory Stick Duo,” refer also to the “Memory Stick Duo” section. (p. 117)

Symptom	Cause and/or Corrective Actions
Cannot play back.	→If the tape has reached the end, rewind the tape. (p. 49)
Horizontal lines appear on the picture. The displayed pictures are not clear or do not appear.	→Clean the head using the cleaning cassette (optional). (p. 132)
No sound or only a low sound is heard.	<ul style="list-style-type: none"> →Set [MULTI-SOUND] to [STEREO] in the  (STANDARD SET) menu. (p. 84) →Turn up the volume. (p. 49) →On the  (STANDARD SET) menu, adjust [AUDIO MIX] from the [ST2] (additional sound) side until the sound is heard appropriately. (p. 84) →When you are using an S VIDEO plug, make sure the red and white plugs of the A/V connecting cable are connected as well. (p. 59)
The sound breaks off.	→Clean the head using the cleaning cassette (optional). (p. 132)
Cannot perform the Date search with the recording date displayed on the screen.	<ul style="list-style-type: none"> →Use a cassette with Cassette Memory. (p. 125) →Set [] SEARCH] to [ON] in the  (EDIT/PLAY) menu. (p. 80) • There is a blank section in the beginning or middle of the tape. This is not a malfunction.
“---” is displayed on the screen.	<ul style="list-style-type: none"> • The tape you are playing was recorded without setting the date and time. • A blank section on the tape is being played. • The data code on a tape with a scratch or noise cannot be read.
END SEARCH does not work.	<ul style="list-style-type: none"> • The cassette was ejected after recording when using a cassette without Cassette Memory. (p. 125) • The cassette is new and has nothing recorded.
END SEARCH does not work correctly.	<ul style="list-style-type: none"> • There is a blank section in the beginning or middle of the tape. This is not a malfunction.

Symptom	Cause and/or Corrective Actions
Noises appear and PAL is displayed on the screen.	<ul style="list-style-type: none"> • The tape was recorded in a TV color system other than that of your camcorder. This is not a malfunction. (p. 124)







"Memory Stick Duo"





Symptom	Cause and/or Corrective Actions
Cannot operate functions using the "Memory Stick Duo."	<ul style="list-style-type: none"> → Set the POWER switch to the CAMERA-MEMORY or PLAY/EDIT mode. (p. 19) → Insert a "Memory Stick Duo" into your camcorder. (p. 24) • The "Memory Stick Duo" was formatted on a personal computer. <ul style="list-style-type: none"> → Format it on your camcorder (Note that all recorded data will be deleted). (p. 72)
Cannot record on the "Memory Stick Duo."	<ul style="list-style-type: none"> → When you are using the "Memory Stick Duo" with the write-protect tab, release the lock on the write-protect tab of the "Memory Stick Duo." (p. 127) → The capacity is full. Delete unnecessary pictures recorded on the "Memory Stick Duo." (p. 106) → Format the "Memory Stick Duo" on your camcorder or insert another "Memory Stick Duo." (p. 72)
The pictures are not played back in the actual size.	<ul style="list-style-type: none"> • Pictures recorded on other devices may not appear in the actual size. This is not a malfunction.
Image data cannot be played back.	<ul style="list-style-type: none"> • Image data cannot be played back if you have modified files or folders, or have edited the data on a computer. (The file name flashes in that case.) This is not a malfunction. (p. 128) • Pictures recorded on other devices may not be played back. This is not a malfunction.
The picture you have recorded on the tape has also been recorded on the "Memory Stick Duo."	<ul style="list-style-type: none"> → The picture was recorded on a "Memory Stick Duo" because you pressed REC START/STOP during tape playback. Delete the picture from the "Memory Stick Duo" if the picture is unnecessary. (p. 106)
Pictures cannot be deleted.	<ul style="list-style-type: none"> → When you are using the "Memory Stick Duo" with the write-protect tab, release the lock on the write-protect tab of the "Memory Stick Duo." (p. 127) → Cancel image protection on the picture. (p. 107) • The maximum number of pictures that you can delete at one time is 100. Delete them in groups of less than 100 pictures each.
Cannot format the "Memory Stick Duo."	<ul style="list-style-type: none"> → When you are using the "Memory Stick Duo" with the write-protect tab, release the lock on the write-protect tab of the "Memory Stick Duo." (p. 127)
Cannot delete all pictures at once.	<ul style="list-style-type: none"> → When you are using the "Memory Stick Duo" with the write-protect tab, release the lock on the write-protect tab of the "Memory Stick Duo." (p. 127) → Cancel image protection on the picture. (p. 107)

→ *continued*

Symptom	Cause and/or Corrective Actions
Image protection cannot be applied.	<ul style="list-style-type: none"> →When you are using the “Memory Stick Duo” with the write-protect tab, release the lock on the write-protect tab of the “Memory Stick Duo.” (p. 127) →Perform the operation again on the index screen. (p. 107)
Cannot mark pictures for print.	<ul style="list-style-type: none"> →When you are using the “Memory Stick Duo” with the write-protect tab, release the lock on the write-protect tab of the “Memory Stick Duo.” (p. 127) →Perform the operation again on the index screen. (p. 108) • The maximum number of pictures you can mark for print is 999. • Movies cannot be marked for print.
The data file name is not indicated correctly.	<ul style="list-style-type: none"> • Only the file name is displayed if the directory structure does not conform to the universal standard. • The file is damaged. • The file format is not supported on your camcorder. (p. 126)
The data file name flashes.	<ul style="list-style-type: none"> • The file is damaged. • The file format is not supported on your camcorder. (p. 126)

Dubbing/Editing

Symptom	Cause and/or Corrective Actions
Pictures from connected devices are not displayed on the LCD screen or the viewfinder.	<ul style="list-style-type: none"> • Cannot change the setting of the A/V jack during Easy Handycam operation. →Cancel Easy Handycam operation (p. 54), and then set [VIDEO INPUT] to the appropriate signal in the  (STANDARD SET) menu. (p. 85) →Set [VIDEO INPUT] to the appropriate signal in the  (STANDARD SET) menu. (p. 85) →Set [DISPLAY] to [LCD PANEL] in the  (STANDARD SET) menu. (p. 87)
Cannot dub correctly using the A/V connecting cable.	<ul style="list-style-type: none"> →Set [VIDEO INPUT] to the appropriate signal in the  (STANDARD SET) menu. (p. 85) →Set [DISPLAY] to [LCD PANEL] in the  (STANDARD SET) menu. (p. 87) • The A/V connecting cable is not connected properly. →Make sure that the A/V connecting cable is connected to the proper jack, i.e. to the output jack of a device you are dubbing a picture from, or to the input jack of another device for dubbing a picture from your camcorder.
Pictures from connected devices are not displayed correctly.	<ul style="list-style-type: none"> • The input signal is not NTSC. (p. 94)
New sound added to a recorded tape is not heard.	<ul style="list-style-type: none"> →In the  (STANDARD SET) menu, adjust [AUDIO MIX] from the [ST1] (original sound) side until the sound is heard appropriately. (p. 84)
A title is not recorded/A cassette label is not recorded.	<ul style="list-style-type: none"> →Use a cassette with Cassette Memory. (p. 125) →Erase unnecessary titles when the Cassette Memory is full. (p. 81) →Set the write-protect tab to REC. (p. 125) • A title cannot be added to a blank section of the tape.







Symptom	Cause and/or Corrective Actions
The title is not displayed.	<ul style="list-style-type: none"> →Set [ TITLE DISP] to [ON] in the  (EDIT/PLAY) menu. (p. 82) • The title cannot be displayed during Easy Handycam operation.
The title cannot be deleted.	<ul style="list-style-type: none"> →Set the write-protect tab to REC. (p. 125)
The Title search does not work.	<ul style="list-style-type: none"> →Enter a title if there is no title on the tape. (p. 80) →Use a cassette with Cassette Memory. (p. 125) →Set [ SEARCH] to [ON] in the  (EDIT/PLAY) menu. (p. 80) • There is a blank section in the beginning or middle of the tape. This is not a malfunction.
Still pictures cannot be dubbed from a tape to a “Memory Stick Duo.”	<ul style="list-style-type: none"> • You cannot record or a distorted picture may be recorded if the tape has been used repeatedly for recording.
Movies cannot be dubbed from a tape to a “Memory Stick Duo.”	<ul style="list-style-type: none"> • You cannot record or a distorted picture may be recorded in the following: <ul style="list-style-type: none"> – The tape has a blank section. – The tape has been used repeatedly for recording. – Input signal has been interrupted or cut.
Digital program editing on the tape does not function.	<ul style="list-style-type: none"> →Set the input selector on the VCR correctly, then check the connection between your camcorder and the VCR. (p. 92) →When your camcorder is connected to a DV device that is not a Sony product via an i.LINK cable, select [IR] in step11 of “Step 1: Preparing your camcorder and VCR for operation” (p. 97). →Adjust the synchronization of the VCR. (p. 100) →Enter a correct [IR SETUP] code. (p. 99) →Select the mode used to cancel recording pause again. (p. 99) →Set your camcorder and the VCR more than 30 cm (12 in.) apart. (p. 99) • The program cannot be set to a blank section on the tape.
The VCR is not responding properly during Digital program editing when it is connected via an i.LINK cable.	<ul style="list-style-type: none"> →While connecting via an i.LINK cable, select [IR] in step 11 of “Step 1: Preparing your camcorder and VCR for operation” (p. 97).
Digital program editing on the “Memory Stick Duo” does not function correctly.	<ul style="list-style-type: none"> • The program cannot be set to a blank section on the tape. • You cannot record or a distorted picture may be recorded if the tape has been used repeatedly for recording.

Warning indicators and messages

Self-diagnosis display/Warning indicators

If indicators appear on the screen or in the viewfinder, check the following. See the page in parentheses for details.









Indication	Cause and/or Corrective Actions
C:□□:□□/E:□□:□□ (Self-diagnosis display)	<p>Some symptoms can be fixed by yourself. If the problem persists even after you tried a couple of times, contact your Sony dealer or local authorized Sony service facility.</p> <p>C:04:□□</p> <p>→ A battery pack that is not an “InfoLITHIUM” battery pack is being used. Use an “InfoLITHIUM” battery pack. (p. 129)</p> <p>C:21:□□</p> <p>→ Moisture condensation has occurred. Remove the cassette and leave your camcorder for at least 1 hour, then re-insert the cassette. (p. 132)</p> <p>C:22:□□</p> <p>→ Clean the head using a cleaning cassette (optional). (p. 132)</p> <p>C:31□□ / C:32□□</p> <p>→ Symptoms that are not described above have occurred. Remove and insert the cassette, then operate your camcorder again. Do not perform this procedure if moisture starts to condense. (p. 132)</p> <p>→ Remove the power source. Reconnect it again and operate your camcorder again.</p> <p>→ Change the cassette. Press RESET button (p. 138), and operate your camcorder again.</p> <p>E:61:□□ / E:62:□□</p> <p>→ Contact your Sony dealer or local authorized Sony service facility. Inform them of the 5-digit code, which starts from “E.”</p>
101-0001 (Warning indicator pertaining to files)	<ul style="list-style-type: none"> • The file is damaged. • The file is unreadable. • You are trying to carry out the MEMORY MIX function on a movie (p. 45).
⏻ (Battery level warning)	<ul style="list-style-type: none"> • The battery pack is nearly used up. • Depending on the operating, environmental, or battery conditions, the ⏻ indicator may flash, even if there are approximately 5 to 10 minutes remaining.
🔌 (Moisture condensation warning)*	<p>→ Eject the cassette, set the POWER switch to OFF (CHG), and leave it for about 1 hour with the cassette lid open (p. 132).</p>
📄 (Warning indicator pertaining to the “Memory Stick Duo”)	<ul style="list-style-type: none"> • No “Memory Stick Duo” is inserted.
📄 (Warning indicator pertaining to “Memory Stick Duo” formatting)*	<ul style="list-style-type: none"> • The “Memory Stick Duo” data is damaged. • The “Memory Stick Duo” is not formatted correctly (p. 72).

Indication	Cause and/or Corrective Actions
 (Warning indicator pertaining to incompatible “Memory Stick Duo”)*	<ul style="list-style-type: none"> • An incompatible “Memory Stick Duo” is inserted.
 (Warning indicator pertaining to the tape)	<p>Slow flashing:</p> <ul style="list-style-type: none"> • There is less than 5 minutes remaining on the tape. • No cassette is inserted.* • The write-protect tab on the cassette is set to lock (p. 125).* <p>Fast flashing:</p> <ul style="list-style-type: none"> • The tape has run out.*
 (Eject cassette warning)*	<p>Slow flashing:</p> <ul style="list-style-type: none"> • The write-protect tab on the cassette is set to lock (p. 125). <p>Fast flashing:</p> <ul style="list-style-type: none"> • Moisture condensation has occurred (p. 132). • The self-diagnosis display code is displayed (p. 120).
 (Warning indicator pertaining to image deletion)*	<ul style="list-style-type: none"> • The image is protected (p. 107).
  (Warning indicator pertaining to the write-protect of the “Memory Stick Duo”)	<ul style="list-style-type: none"> • The write-protect tab on the “Memory Stick Duo” is set to lock (p. 127).
 (Warning indicator pertaining to the flash (optional))	<p>Slow flashing:</p> <ul style="list-style-type: none"> • During charging <p>Fast flashing:</p> <ul style="list-style-type: none"> • There is something wrong with the external flash (optional).







* You hear a melody or beep sound when the warning indicators appear on the screen.



Warning messages

If messages appear on the screen, check the following. See the page in parentheses for details.

Subjects	Indications	Corrective Actions/References
Battery	Use the “InfoLITHIUM” battery pack.	→ See page 129.
	Battery level is low.	→ Charge the battery (p. 16).
	Old battery. Use a new one.	→ See page 129.
	 Re-attach the power source.	–
Moisture condensation	  Moisture condensation. Eject the cassette.	→ See page 132.
	 Moisture condensation. Turn off for 1H.	→ See page 132.
Cassette/Tape	 Insert a cassette.	→ See page 23.
	 Reinsert the cassette.	→ Check if the cassette is damaged, etc.
	  The tape is locked - check the tab.	→ See page 125.
	 The tape has reached the end.	–
	Use a cassette with Cassette Memory.	→ See page 125.

→ continued

Subjects	Indications	Corrective Actions/ References
“Memory Stick Duo”	 Insert a Memory Stick.	→ See page 24.
	 Reinsert the Memory Stick.	→ Reinsert the “Memory Stick Duo” a few times. If even then the indicator flashes, the “Memory Stick Duo” might be damaged. Try with another “Memory Stick Duo.”
	Do not eject the Memory Stick during writing.	–
	This is a read-only Memory Stick.	→ Insert a writable “Memory Stick Duo.”
	 Incompatible type of Memory Stick.	→ The type of “Memory Stick Duo” incompatible with your camcorder is inserted (p. 126).
	 This Memory Stick is not formatted correctly.	→ Check the format, then format the “Memory Stick Duo” as necessary (p. 72).
	Cannot record. The Memory Stick is full.	→ Delete unnecessary images (p. 106).
	  The Memory Stick is locked - check the tab.	→ See page 126.
	Cannot playback. Reinsert the Memory Stick.	–
	Cannot record. Reinsert the Memory Stick.	–
	No file.	<ul style="list-style-type: none"> • No file is recorded or there is no readable file on the “Memory Stick Duo.”
	NO FILE AVAILABLE.	<ul style="list-style-type: none"> • There is no file in the selected folder.
	USB streaming... This function is not available.	<ul style="list-style-type: none"> • You tried to play back or record on a “Memory Stick Duo” during USB Streaming.
	Memory Stick folders are full.	<ul style="list-style-type: none"> • You cannot create folders exceeding 999MSDCF. → You cannot delete the created folders using your camcorder. You will have to format the “Memory Stick Duo” (p. 72), or delete them using your computer.
	Cannot record still images on Memory Stick.	–
PictBridge compliant printer	Check the connected device.	→ Switch off the printer and switch it on again, then disconnect the USB cable and reconnect it.
	Connect the camcorder to a PictBridge compatible printer.	→ Switch off the printer and switch it on again, then disconnect the USB cable and reconnect it.
	Check the printer.	→ Check the printer.
	Error-Cancel the task.	→ Check the printer.
	Cannot print. Check the printer.	→ Switch off the printer and switch it on again, then disconnect the USB cable and reconnect it.

Subjects	Indications	Corrective Actions/ References
FLASH	Charging... Cannot record still images.	• You are trying to record a still image while charging the flash (optional).
Others	Cannot record due to copyright protection.	–
	Cannot add audio. Disconnect the i.LINK cable.	→See page 104.
	Not recorded in SP mode. Cannot add audio.	→See page 104.
	Not recorded in 12-bit audio. Cannot add audio.	→See page 104.
	Cannot add audio on the blank portion of a tape.	→See page 104.
	Cassette Memory is full.	→See page 82.
	Cannot record 44.1 kHz audio on a Memory Stick.	–
	Already added to CAMERA-TAPE mode's P-MENU.	–
	Already added to CAMERA-MEMORY mode's P-MENU.	–
	Already added to PLAY/EDIT mode's P-MENU.	–
	 Dirty video head. Use a cleaning cassette.	→See page 132.
	Cannot start Easy Handycam	–
	Cannot cancel Easy Handycam	–
	Cannot start Easy Handycam with USB connected	–
	Cannot cancel Easy Handycam with USB connected	–
	Invalid button with Easy Handycam operation	–
	USB is invalid in this mode during Easy Handycam	• You can select [STD-USB] in PLAY/EDIT mode during Easy Handycam operation, but you cannot select [PictBridge] or [USB STREAM]. (The message disappears when you touch 
	HDV recorded tape. Cannot playback.	→Your camcorder cannot play back this format. Play back the tape with equipment that recorded it.
	HDV recorded tape. Cannot add audio.	→Your camcorder cannot play back this format. Add audio with equipment that recorded it.
	Cover is not open.	→Open the lens cover.

Using your camcorder abroad

Power supply

You can use your camcorder in any countries/regions using the AC Adaptor supplied with your camcorder within AC 100 V to 240 V, 50/60 Hz.

Use a commercially available AC plug adaptor [a], if necessary, depending on the design of the wall outlet [b].



Simple setting of clock by time difference

You can easily set the clock to the local time by setting a time difference when using your camcorder abroad. Select [WORLD TIME] in the (TIME/LANGU.) menu, then set the time difference (p. 88).

On TV color systems

Your camcorder is an NTSC system-based camcorder. If you want to view the playback picture on a TV, it must be an NTSC system-based TV (see following list) with the AUDIO/VIDEO input jack.

System	Used in
NTSC	Bahama Islands, Bolivia, Canada, Central America, Chile, Colombia, Ecuador, Guyana, Jamaica, Japan, Korea, Mexico, Peru, Surinam, Taiwan, the Philippines, the U.S.A., Venezuela, etc.
PAL	Australia, Austria, Belgium, China, Czech Republic, Denmark, Finland, Germany, Holland, Hong Kong, Hungary, Italy, Kuwait, Malaysia, New Zealand, Norway, Poland, Portugal, Singapore, Slovak Republic, Spain, Sweden, Switzerland, Thailand, United Kingdom, etc.
PAL - M	Brazil
PAL - N	Argentina, Paraguay, Uruguay
SECAM	Bulgaria, France, Guiana, Iran, Iraq, Monaco, Russia, Ukraine, etc.

Usable cassette tapes

You can use the mini DV format cassette only. Use a cassette with the ^{Mini}DV mark.

Mini DV Digital Video Cassette is a trademark.

Cassette Memory

There are 2 types of mini DV cassettes: those with Cassette Memory and those without Cassette Memory. Cassettes with Cassette Memory have the **CM** (Cassette Memory) mark. A cassette with Cassette Memory is recommended for use on your camcorder.

CM Cassette Memory is a trademark.

IC memory is mounted on this type of cassette. Your camcorder can read and write data such as dates of recording or titles from/to this memory. The functions using the Cassette Memory require successive signals recorded on the tape. If the tape has a blank section at the beginning or between recorded sections, titles may not be displayed properly or the search functions may not work properly.

To prevent a blank section from being made on the tape

Touch **→I** to go to the end of the recorded section before you begin the next recording in the following cases:

- You have ejected the cassette during recording.
- You have played back the tape.
- You have used EDIT SEARCH.

If there is a blank section or discontinuous signals on your tape, re-record from the beginning to the end of the tape as described above.

Note

- The Cassette Memory may not function correctly when you record using a digital video camera recorder that does not support Cassette Memory, on a tape already recorded on using a Cassette Memory-compatible digital video camera recorder.

Tip

- The memory capacity of the cassette marked with **CM 4K** is 4k bits. Your camcorder can accommodate cassettes having a memory capacity of up to 16k bits.

Copyright signal

When you play back

If the cassette you play back on your camcorder contains copyright signals, you cannot copy it to a tape in another video camera connected to your camcorder.

When you record

You cannot record software on your camcorder that contains copyright control signals for copyright protection of software.

[Cannot record due to copyright protection.] appears on the LCD screen, or on the TV screen if you try to record such software.

Your camcorder does not record copyright control signals on the tape when it records.

Notes on use

To prevent accidental erasure

Slide the write-protect tab on the cassette to set to SAVE.

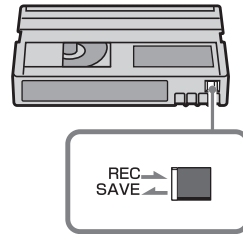

REC: The cassette can be recorded.

SAVE: The cassette cannot be recorded (write-protected).

When labeling the cassette

Be sure to place the label only on the locations as shown in the following illustration so as not to cause malfunction of your camcorder.

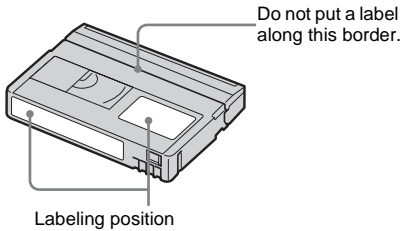

After using the cassette

Rewind the tape to the beginning to avoid distortion of the picture or the sound. The cassette should then be put in its case, and stored in an upright position.

When the Cassette Memory function does not work

Re-insert the cassette. Cassette Memory may not work when the gold-plated connector is dirty or dusty.

When cleaning the gold-plated connector

Generally, clean the gold-plated connector on a cassette with a cotton-wool swab after every 10 times it has been ejected.

If the gold-plated connector on the cassette is dirty or dusty, the remaining tape indicator may not be indicated correctly, and you may not be able to operate functions using Cassette Memory.

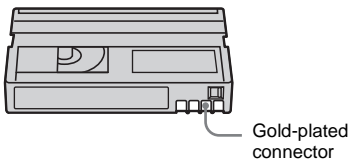

About the “Memory Stick”

The “Memory Stick” is a new light and small recording media which, despite its size, can store more data than a floppy disk. You can use following types of “Memory Stick” on your camcorder. However, appearance on the list does not guarantee the operation of all types of “Memory Stick Duo” on your camcorder.

Types of “Memory Stick”	Recording/ Playback
“Memory Stick”	–
“Memory Stick Duo” ^{*1}	○
“MagicGate Memory Stick”	–
“Memory Stick Duo” (MagicGate/Parallel Transfer) ^{*1}	○ ^{2*3}
“MagicGate Memory Stick Duo” ^{*1}	○ ³
“Memory Stick PRO”	–
“Memory Stick PRO Duo” ^{*1}	○ ^{2*3}

*1 The “Memory Stick Duo” is about half the size of a standard “Memory Stick.”

*2 The types of “Memory Stick” that support high speed data transfer. The speed of data transfer varies depending on the device to be used.

*3 “MagicGate” is a copyright protection technology that records and transfers the contents in an encrypted format. Note that data that uses “MagicGate” technology cannot be recorded or played on your camcorder.

- Still image format: Your camcorder compresses and records image data in the JPEG (Joint Photographic Experts Group) format. The file extension is “.JPG.”
- Movie format: Your camcorder compresses and records picture data in the MPEG (Moving Picture Experts Group) format. The file extension is “.MPG.”
- File names of still images:
 - 101-0001: This file name appears on the screen of your camcorder.
 - DSC00001.JPG: This file name appears on the display of a computer.

- File names of movies:
 - MOV00001: This file name appears on the screen of your camcorder.
 - MOV00001.MPG: This file name appears on the display of a computer.
- On a “Memory Stick Duo” formatted on a computer: A “Memory Stick Duo” formatted by the Windows OS or using Macintosh computers does not have guaranteed compatibility with your camcorder.
- Data read/write speed may vary depending on the combination of the “Memory Stick” and “Memory Stick” compliant product you use.

To prevent accidental erasure of images

Slide the write-protect tab* on the “Memory Stick Duo” with a small tapered object, to the write-protect position.

The position or the shape of the write-protect tab* may differ depending on the “Memory Stick Duo” you use.

*The “Memory Stick Duo” supplied with your camcorder is not equipped with the write-protect tab.

When using the supplied “Memory Stick Duo,” be careful not to edit or delete data by mistake.

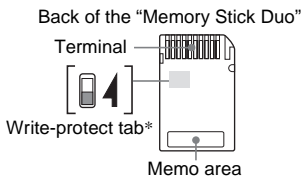

Notes on use

Image data may be damaged in the following cases. Compensation for damaged image data will not be made.

- If you eject the “Memory Stick Duo,” turn the power off on your camcorder, or remove the battery pack for replacement while your camcorder is reading or writing image files on the “Memory Stick Duo” (while the access lamp is lit or flashing).
- If you use the “Memory Stick Duo” near magnets or magnetic fields.

It is recommended you take a back-up of important data on the hard disk of a computer.

On handling

Keep the following notes in mind when handling a “Memory Stick Duo.”

- Be careful not to apply excessive force when writing on a memo area on a “Memory Stick Duo.”
- Do not attach a label or the like on a “Memory Stick Duo” or a Memory Stick Duo adaptor.
- When you carry or store a “Memory Stick Duo,” put it in its case.
- Do not touch, or allow metallic objects to come into contact with the terminal.
- Do not bend, drop or apply strong force to the “Memory Stick Duo.”
- Do not disassemble or modify the “Memory Stick Duo.”
- Do not let the “Memory Stick Duo” get wet.
- Be careful to keep “Memory Stick Duo” media out of the reach of small children. There is danger that a child might swallow it.
- Do not insert any objects other than a compliant “Memory Stick Duo” into the “Memory Stick Duo” slot. It may cause a malfunction.

On location for use

Do not use or keep the “Memory Stick Duo” in the following locations.

- Places subject to extremely high temperature, such as a car parked outside in the summer.
- Places under direct sunlight.
- Places with extremely high humidity or subject to corrosive gases.

Notes on using a Memory Stick Duo adaptor (supplied)

- When using a “Memory Stick Duo” with a “Memory Stick” compliant device, be sure to insert a “Memory Stick Duo” into a Memory Stick Duo adaptor.
- When inserting a “Memory Stick Duo” into a Memory Stick Duo adaptor, make sure the “Memory Stick Duo” is inserted facing in the correct direction, then insert it all the way in. Note that improper use may damage the device.
- Do not insert a Memory Stick Duo adaptor without a “Memory Stick Duo” attached. Doing so may result in malfunctions of the unit.

→ continued

Notes on using the “Memory Stick PRO Duo” and “Memory Stick Duo” (MagicGate/Parallel Transfer)

- The maximum memory capacity of a “Memory Stick PRO Duo” that can be used on your camcorder is up to 512 MB, and that of a “Memory Stick Duo” (MagicGate/Parallel Transfer) is up to 128 MB.
- This unit does not support high speed data transfer.

Notes on image data compatibility

- Image data files recorded on a “Memory Stick Duo” by your camcorder conform to the Design Rule for Camera File Systems universal standard established by the JEITA (Japan Electronics and Information Technology Industries Association).
- On your camcorder, you cannot play back still images recorded on other device (DCR-TRV890E/TRV900/TRV900E or DSC-D700/D770) that does not conform to the universal standard. (These models are not sold in some regions.)
- If you cannot use a “Memory Stick Duo” that has been used with other device, format it with your camcorder (p. 72). Note that formatting erases all information on the “Memory Stick Duo.”
- You may not be able to play back images with your camcorder:
 - When playing back image data modified on your computer.
 - When playing back image data recorded with other device.

-
- “Memory Stick Duo” and “MEMORY STICK DUO” are trademarks of Sony Corporation.
 - “Memory Stick PRO Duo” and “MEMORY STICK PRO DUO” are trademarks of Sony Corporation.
 - “MagicGate Memory Stick Duo” is a trademark of Sony Corporation.
 - “Memory Stick,”  and “MagicGate Memory Stick” are trademarks of Sony Corporation.
 - “Memory Stick PRO” and “MEMORY STICK PRO” are trademarks of Sony Corporation.
 - “MagicGate” and “MAGICGATE” are trademarks of Sony Corporation.

- All other product names mentioned herein may be the trademarks or registered trademarks of their respective companies. Furthermore, “™” and “®” are not mentioned in each case in this manual.

About the “InfoLITHIUM” battery pack

This unit is compatible with the “InfoLITHIUM” battery pack (P series). Your camcorder operates only with the “InfoLITHIUM” battery pack. “InfoLITHIUM” P series battery packs have the



What is the “InfoLITHIUM” battery pack?

The “InfoLITHIUM” battery pack is a lithium-ion battery pack that has functions for communicating information related to operating conditions between your camcorder and an optional AC Adaptor/charger.

The “InfoLITHIUM” battery pack calculates the power consumption according to the operating conditions of your camcorder, and displays the remaining battery time in minutes. With an AC Adaptor/charger (optional), the remaining battery time and charging time appear.

To charge the battery pack

- Be sure to charge the battery pack before you start using your camcorder.
- We recommend charging the battery pack in an ambient temperature of between 10°C to 30°C (50°F to 86°F) until the CHG (charge) lamp turns off. If you charge the battery pack outside of this temperature range, you may not be able to charge it efficiently.
- After charging is complete, disconnect the cable from the DC IN jack on your camcorder, or remove the battery pack.

To use the battery pack effectively

- Battery pack performance decreases when the surrounding temperature is 10°C (50°F) or below, and the length of time you can use the battery pack becomes shorter. In that case, do one of the following to use the battery pack for a longer time.

- Put the battery pack in a pocket to warm it up, and insert it in your camcorder right before you start taking shots.
- Use a large capacity battery pack: NP-FP70/FP90 (optional).
- Frequent use of the LCD screen or a frequent playback, fast forward or rewind operation wears out the battery pack faster. We recommend using a large capacity battery pack: NP-FP70/FP90 (optional).
- Be sure to set the POWER switch to OFF (CHG) when not recording or playing back on your camcorder. The battery pack is also consumed when your camcorder is in recording standby or playback pause.
- Have spare battery packs ready for two or three times the expected recording time, and make trial recordings before making the actual recording.
- Do not expose the battery pack to water. The battery pack is not water resistant.

About remaining battery time indicator

- When the power goes off even though the remaining battery time indicator indicates that the battery pack has enough power to operate, charge the battery pack fully again. The indication on the remaining battery time will be indicated correctly. Note, however, that the battery indication will not be restored if it is used in high temperatures for a long time, or if left in a fully charged state, or when the battery pack is frequently used. Use the remaining battery time indication as a guide to the approximate shooting time.
- The  mark that indicates low battery flashes even if there are still 5 to 10 minutes of battery time remaining, depending on the operating conditions or ambient temperature and environment.

About storage of the battery pack

- If the battery pack is not used for a long time, fully charge the battery pack and use it on your camcorder once a year to maintain the proper function. To store the battery pack, remove it from your camcorder and put it in a dry, cool place.
- To discharge the battery pack on your camcorder completely, set [A. SHUT OFF] to [NEVER] on the  (STANDARD SET)

→ continued

menu and leave your camcorder in tape recording standby until the power goes off (p. 87).

About battery life

- The battery life is limited. Battery capacity drops little by little as you use it more and more, and as time passes. When the available battery time is shortened considerably, a probable cause is that the battery pack has reached the end of its life. Please buy a new battery pack.
- The battery life varies depending on how it is stored and the operating conditions and environment for each battery pack.

“InfoLITHIUM” is a trademark of Sony Corporation.

About i.LINK

The DV Interface on this unit is an i.LINK-compliant DV Interface. This section describes the i.LINK standard and its features.

What is i.LINK?

i.LINK is a digital serial interface for transferring digital video, digital audio, and other data to other i.LINK-compatible device. You can also control other device using the i.LINK.

i.LINK-compatible device can be connected using an i.LINK cable. Possible applications are operations and data transactions with various digital AV devices.

When two or more i.LINK-compatible device are connected to this unit in a daisy chain, operations and data transactions are possible with not only the device that this unit is connected to but also with other devices via the directly connected device.

Note, however, that the method of operation sometimes varies according to the characteristics and specifications of the device to be connected. Also, operations and data transactions may not be possible on some connected device.

Note

- Normally, only one device can be connected to this unit with the i.LINK cable. When connecting this unit to i.LINK-compatible device having two or more DV Interfaces, refer to the operating instructions of the device to be connected.

Tips

- i.LINK is a more familiar term for the IEEE 1394 data transport bus proposed by Sony, and is a trademark approved by many corporations.
- IEEE 1394 is an international standard standardized by the Institute of Electrical and Electronics Engineers.

About i.LINK Baud rate

i.LINK's maximum baud rate varies according to the device. There are three types.

S100 (approx. 100Mbps*)

S200 (approx. 200Mbps)

S400 (approx. 400Mbps)

The baud rate is listed under “Specifications” in the operating instructions of each piece of

device. It is also indicated near the i.LINK interface on some device.
The maximum baud rate for device that does not have any indication (such as this unit) is “S100.”

The baud rate may differ from the indicated value when the unit is connected to device with a different maximum baud rate.

* What is Mbps?

Mbps stands for “megabits per second,” or the amount of data that can be sent or received in one second. For example, a baud rate of 100 Mbps means that 100 megabits of data can be sent in one second.

To use i.LINK functions on this unit

For details on how to dub when this unit is connected to other video device having a DV Interface, see page 92, 93.

This unit can also be connected to other i.LINK (DV Interface) compatible device made by Sony (e.g. a VAIO series personal computer) as well as to video device.

Before connecting this unit to your computer, make sure that application software supported by this unit is already installed on your computer.

Some i.LINK compatible video device such as Digital Televisions, DVD recorders/players, and MICROMV recorders/players are not compatible with DV device. Before connecting to other device, be sure to confirm whether the device is compatible with DV device or not. For details on precautions and compatible application software, refer also to the operating instructions for the device to be connected.

About the required i.LINK cable

Use the Sony i.LINK 4-pin-to-4-pin cable (during DV dubbing).

i.LINK and  are trademarks of Sony Corporation.

Maintenance and precautions

On use and care

- Do not use or store the camcorder and accessories in the following locations.
 - Anywhere extremely hot or cold. Never leave them exposed to temperatures above 60°C (140°F), such as under direct sunlight, near heaters or in a car parked in the sun. They may malfunction or become deformed.
 - Near strong magnetic fields or mechanical vibration. The camcorder may malfunction.
 - Near strong radio waves or radiation. The camcorder may not be able to record properly.
 - Near AM receivers and video equipment. Noise may occur.
 - Sandy beach or anywhere dusty. If sand or dust gets in your camcorder, it may malfunction. Sometimes this malfunction cannot be repaired.
 - Near windows or outdoors, where the LCD screen, the viewfinder, or the lens may be exposed to direct sunlight. This damages the inside of the viewfinder or the LCD screen.
 - Anywhere very humid.
- Operate your camcorder on DC 7.2 V (battery pack) or DC 8.4 V (AC Adaptor).
- For DC or AC operation, use the accessories recommended in these operating instructions.
- Do not let your camcorder get wet, for example, from rain or sea water. If your camcorder gets wet, it may malfunction. Sometimes this malfunction cannot be repaired.
- If any solid object or liquid get inside the casing, unplug your camcorder and have it checked by a Sony dealer before operating it any further.
- Avoid rough handling, disassembling, modifying, or mechanical shock. Be particularly careful of the lens.
- Keep the POWER switch setting to OFF (CHG) when you are not using your camcorder.

- Do not wrap your camcorder with a towel, for example, and operate it. Doing so might cause heat to build up inside.
- When disconnecting the power cord, pull by the plug and not the cord.
- Do not damage the power cord such as by placing anything heavy on it.
- Keep metal contacts clean.
- Keep the Remote Commander and button-type battery out of children's reach. If the battery is accidentally swallowed, consult a doctor immediately.
- If the battery electrolytic liquid has leaked,
 - consult your local authorized Sony service facility.
 - wash off any liquid that may have contacted your skin.
 - if any liquid gets in your eyes, wash with plenty of water and consult a doctor.

When not using your camcorder for a long time

Occasionally turn it on and let it run such as by playing back tapes for about 3 minutes. Otherwise, unplug it from the wall outlet.

Moisture condensation

If your camcorder is brought directly from a cold place to a warm place, moisture may condense inside your camcorder, on the surface of the tape, or on the lens. In this state, the tape may stick to the head drum and be damaged or your camcorder may not operate correctly. If there is moisture inside your camcorder, [☒]▲ Moisture condensation. Eject the cassette] or [☒] Moisture condensation. Turn off for 1H.] appears. The indicator will not appear when the moisture condenses on the lens.

If moisture condensation has occurred

None of the functions except cassette ejection will work. Eject the cassette, turn off your camcorder, and leave it for about one hour with the cassette lid open. Your camcorder can be used again if [☒] or ▲ does not appear when the power is turned on again.

If moisture starts to condense, your camcorder sometimes cannot detect condensation. If this happens, the cassette is sometimes not ejected for 10 seconds after the cassette lid is opened. This is not a malfunction. Do not close the cassette lid until the cassette is ejected.

Note on moisture condensation

Moisture may condense when you bring your camcorder from a cold place into a warm place (or vice versa) or when you use your camcorder in a humid place as shown below.

- When you bring your camcorder from a ski slope into a place warmed up by a heating device.
- When you bring your camcorder from an air-conditioned car or room into a hot place outside.
- When you use your camcorder after a squall or a shower.
- When you use your camcorder in a hot and humid place.

How to prevent moisture condensation

When you bring your camcorder from a cold place into a warm place, put your camcorder in a plastic bag and seal it tightly. Remove the bag when the air temperature inside the plastic bag has reached the surrounding temperature (after about one hour).

Video head

- When the video head becomes dirty, you cannot record pictures normally, or distorted picture or sound is played back.
- If the following problem occurs, clean the video heads for 10 seconds with the Sony DVM-12CLD cleaning cassette (optional).
 - Mosaic-pattern noise appears on the playback picture or the screen is displayed in blue.



- Playback pictures do not move.
- Playback pictures do not appear or the sound breaks off.
- [⊗] Dirty video head. Use a cleaning cassette.] appears on the screen during recording.
- The video head suffers from wear after long use. If you cannot obtain a clear image even after using a cleaning cassette, it might be because the video head is worn. Please contact your Sony dealer or local authorized Sony service facility to have the video head replaced.

LCD screen

- Do not add excessive pressure on the LCD screen, as it may cause damage.
- If your camcorder is used in a cold place, a residual image may appear on the LCD screen. This is not a malfunction.
- While using your camcorder, the back of the LCD screen may heat up. This is not a malfunction.

To clean the LCD screen

- If fingerprints or dust make the LCD screen dirty, it is recommended you use the cleaning cloth (supplied) to clean it. When you use the LCD Cleaning Kit (optional), do not apply the cleaning liquid directly to the LCD screen. Use cleaning paper moistened with the liquid.

On adjustment of the LCD screen (CALIBRATION)

The buttons on the touch panel may not work correctly. If this happens, follow the procedure below. It is recommended you connect your camcorder to the wall outlet using the supplied AC Adaptor during the operation.

- 1 Slide the POWER switch up to OFF (CHG).**
- 2 Eject the cassette and “Memory Stick Duo” from your camcorder, then disconnect any connecting cables except the AC Adaptor from your camcorder.**
- 3 Slide the POWER switch repeatedly to select the PLAY/EDIT mode while pressing DSPL/BATT INFO on your camcorder, then press and hold DSPL/BATT INFO for about 5 seconds.**

4 Touch the “x” displayed on the screen with the corner of the supplied “Memory Stick Duo.”

The position of the “x” changes.

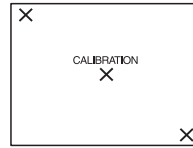

If you did not press the right spot, start from step 4 again.

⚠ Note

- You cannot calibrate the LCD screen if you have rotated the LCD panel and set it with the LCD screen facing out.

On handling the casing

- If the casing is soiled, clean the camcorder body with a soft cloth lightly moistened with water, and then wipe the casing with a dry soft cloth.
- Avoid the following to avoid damage to the finish.
 - Using chemicals such as thinner, benzene, alcohol, chemical cloths, repellent and insecticide.
 - Handling with above substances on your hands.
 - Leaving the casing in contact with rubber or vinyl objects for a long period of time.

About care and storage of the lens

- Wipe the surface of the lens clean with a soft cloth in the following instances:
 - When there are fingerprints on the lens surface.
 - In hot or humid locations
 - When the lens is exposed to salty air such as at the seaside.
- Store in a well-ventilated location subject to little dirt or dust.
- To prevent molds periodically clean the lens as described above.

It is recommended you operate your camcorder about once a month to keep it in an optimum state for a long time.

→ continued

To charge the pre-installed button-type battery

Your camcorder has a pre-installed button-type battery to retain the date, time, and other settings even when the POWER switch is set to OFF (CHG). The pre-installed button-type battery is always charged while you are using your camcorder but it will get discharged gradually if you do not use your camcorder. The button-type battery will be fully discharged in about **3 months** if you do not use your camcorder at all. However, even if the pre-installed button-type battery is not charged, the camcorder operation will not be affected as long as you are not recording the date.

Procedures

Connect your camcorder to a wall outlet using the supplied AC Adaptor, and leave it with the POWER switch set to OFF (CHG) for more than 24 hours.

Specification

Video camera recorder

System

Video recording system

2 rotary heads, Helical scanning system

Still image recording system

Exif Ver. 2.2 *1

*1 "Exif" is a file format for still images, established by the JEITA (Japan Electronics and Information Technology Industries Association). Files in this format can have additional information such as your camcorder's setting information at the time of recording.

Audio recording system

Rotary heads, PCM system

Quantization: 12 bits (Fs 32 kHz, stereo 1, stereo 2), 16 bits (Fs 48 kHz, stereo)

Video signal

NTSC color, EIA standards

Usable cassette

Mini DV cassette with the  mark printed

Tape speed

SP: Approx. 18.81 mm/s

LP: Approx. 12.56 mm/s

Recording/playback time (using a DVM60 cassette)

SP: 60 min

LP: 90 min

Fast forward/rewind time (using a DVM60 cassette)

Approx. 2 min 40 s

Viewfinder

Electric viewfinder (color)

Image device

For DCR-HC40:

3.6 mm (1/5 type) CCD (Charge Coupled Device)

Gross: Approx. 1 070 000 pixels

Effective (still): Approx. 1 000 000 pixels

Effective (movie): Approx. 690 000 pixels

For DCR-HC30:

3 mm (1/6 type) CCD (Charge Coupled Device)

Gross: Approx. 680 000 pixels

Effective (still): Approx. 340 000 pixels
Effective (movie): Approx. 340 000 pixels

Lens

Carl Zeiss Vario-Tessar
Combined power zoom lens
Filter diameter: 25 mm (1 in.)
10 × (Optical), 120 × (Digital)
For DCR-HC40:
F = 1.8 ~ 2.3
For DCR-HC30:
F = 1.7 ~ 2.3

Focal length

For DCR-HC40:
3.2 - 32 mm (5/32 - 1 5/16 in.)
When converted to a 35 mm still camera
In CAMERA-TAPE:
46 - 460 mm (1 13/16 - 18 1/8 in.)
In CAMERA-MEMORY:
38 - 380 mm (1 1/2 - 15 in.)
For DCR-HC30:
2.3 - 23 mm (3/32 - 29/32 in.)
When converted to a 35 mm still camera
In CAMERA-TAPE:
43 - 430 mm (1 3/4 - 17 in.)
In CAMERA-MEMORY:
43 - 430 mm (1 3/4 - 17 in.)

Color temperature

[AUTO], [ONE PUSH], [INDOOR] (3 200 K), [OUTDOOR] (5 800 K)

Minimum illumination

For DCR-HC40:
7 lx (lux) (F 1.8)
0 lx (lux) (during NightShot plus function)*
For DCR-HC30:
5 lx (lux) (F 1.7)
0 lx (lux) (during NightShot plus function)*
* Objects unable to be seen due to the dark can be shot with infrared lighting.

Input/Output connectors

Audio/Video input/output

10-pin connector
Input/output auto switch
Video signal: 1 V_{p-p}, 75 Ω (ohms), unbalanced
Luminance signal: 1 V_{p-p}, 75Ω (ohms), unbalanced
Chrominance signal: 0.286 V_{p-p}, 75Ω (ohms), unbalanced
Audio signal: 327 mV (at output impedance more than 47 kΩ (kilohms)), Input impedance more than 47 kΩ (kilohms), Output impedance with less than 2.2 kΩ (kilohms)

DV input/output

4-pin connector

LANC jack

Stereo mini-minijack (Ø 2.5 mm)

USB jack

mini-B

MIC jack

Minijack, 0.388 mV low impedance with DC 2.5 to 3.0 V, output impedance 6.8 kΩ (kilohms) (Ø 3.5 mm), Stereo type

LCD screen

Picture

6.2 cm (2.5 type)

Total dot number

123 200 (560 × 220)

General

Power requirements

DC 7.2 V (battery pack)
DC 8.4 V (AC Adaptor)

Average power consumption (when using the battery pack)

For DCR-HC40:
During camera recording using the viewfinder 2.9 W
During camera recording using the LCD 3.2 W
For DCR-HC30:
During camera recording using the viewfinder 2.3 W
During camera recording using the LCD 2.6 W

Operating temperature

0°C to 40°C (32°F to 104°F)

Storage temperature

-20°C to +60°C (-4°F to +140°F)

Dimensions (approx.)

For DCR-HC40:
50 × 92 × 112 mm (2 × 3 5/8 × 4 1/2 in.) (w/h/d)
For DCR-HC30:
50 × 86 × 112 mm (2 × 3 1/2 × 4 1/2 in.)

Mass (approx.)

For DCR-HC40:
400 g (14 oz) main unit only
460 g (1 lb) including the NP-FP50 rechargeable battery pack and DVM60 cassette.
For DCR-HC30:
380 g (13 oz) main unit only
440 g (15 oz) including the NP-FP50

→ continued

rechargeable battery pack and DVM60
cassette.

Supplied accessories

See page 15.

AC Adaptor AC-L25A/L25B

Power requirements

AC 100 - 240 V, 50/60 Hz

Current consumption

0.35 - 0.18 A

Power consumption

18 W

Output voltage

DC 8.4 V, 1.5 A

Operating temperature

0°C to 40°C (32°F to 104°F)

Storage temperature

-20°C to + 60°C (-4°F to + 140°F)

Dimensions (approx.)

56 × 31 × 100 mm (2 1/4 × 1 1/4 × 4 in.)
(w/h/d) excluding the projecting parts

Mass (approx.)

190 g (6.7 oz) excluding the power cord

Rechargeable battery pack (NP-FP50)

Maximum output voltage

DC 8.4 V

Output voltage

DC 7.2 V

Capacity

4.9 Wh (680 mAh)

Dimensions (approx.)

31.8 × 18.5 × 45.0 mm
(1 5/16 × 3/4 × 1 13/16 in.) (w/h/d)

Mass (approx.)

40 g (1.5 oz)

Operating temperature

0°C to 40°C (32°F to 104°F)

Type

Lithium ion

Design and specifications are subject to change
without notice.

Identifying parts and controls

Camcorder

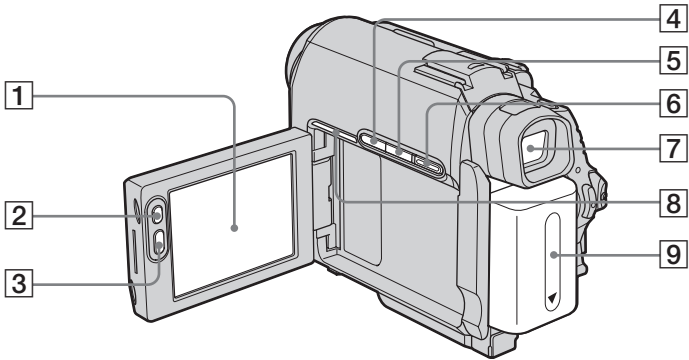

1 LCD/Touch panel screen (p. 4, 20)

2 LCD BACKLIGHT * (p. 20)

3 REC START/STOP (p. 26, 50)

4 BACK LIGHT button * (p. 37)

5 DSPL/BATT INFO button (p. 17)

6 EASY button (p. 34, 54)

7 Viewfinder (p. 4, 21)

8 For DCR-HC40:

Connection Lamp

The Connection Lamp flashes when USB or i.LINK connection is established with other devices and during demonstration.

9 Battery pack (p. 16)

* These buttons are not available during Easy Handycam operation (●mark).

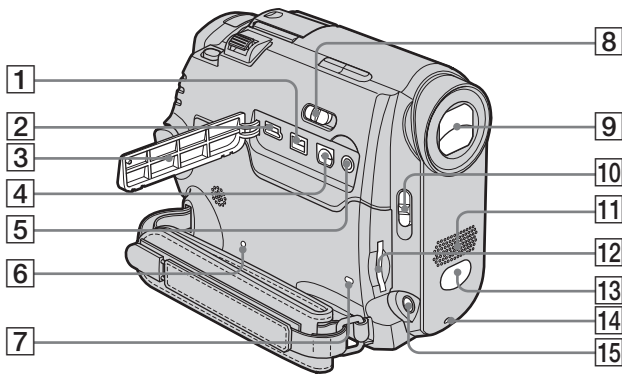

1 **DV Interface**

2 **(USB) jack**

3 **Jack cover**

4 **A/V (audio/video) jack**

5 **(LANC) jack (blue)**

The LANC control jack is used for controlling the tape transport of video device and peripherals connected to it.

6 **RESET button**

If you press RESET, all the settings including the date and time, except the Personal Menu items, return to the default.

7 **Access lamp (p. 24, 127)**

8 **NIGHTSHOT PLUS switch (p. 39)**

9 **Lens (Carl Zeiss Lens)/Lens cover**

Your camcorder is equipped with a Carl Zeiss lens which can reproduce fine images. The lens for your camcorder was developed jointly by Carl Zeiss, in Germany, and Sony Corporation. It adopts the MTF measurement system for video cameras and offers a quality as fine as a Carl Zeiss lens. MTF stands for Modulation Transfer Function. The value number indicates the amount of light from a subject coming into the lens.

10 **LENS COVER switch (19, 26, 31)**

11 **Microphone (p. 104)**

12 **“Memory Stick Duo” slot (p. 24)**



13 **Remote sensor/Infrared ray emitter (p. 99)**

14 **Camera recording lamp (p. 26)**

15 **MIC (PLUG IN POWER) jack (red) (p. 104)**

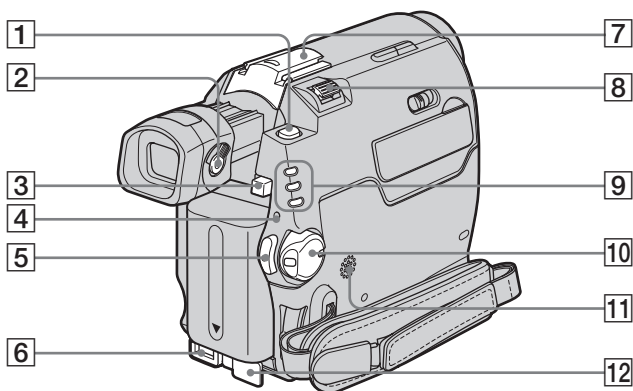
This jack works as an input jack for an external microphone as well as a power-supply jack for a plug-in-power microphone. When the external microphone is connected, it takes precedence.



- | | |
|--|---|
| <p>1 PHOTO button (p. 31)</p> <p>2 Viewfinder lens adjustment lever (p. 21)</p> <p>3 BATT (battery) release button (p. 16)</p> <p>4 CHG (charge) lamp (p. 16)</p> <p>5 REC START/STOP (p. 26, 50)</p> <p>6 DC IN jack (p. 16)</p> <p>7 For DCR-HC40:
Intelligent accessory shoe  / shoe cover (p. 104)</p> <p>For DCR-HC30:
Accessory shoe/shoe cover</p> <ul style="list-style-type: none"> • Remove the shoe cover when you use an accessory. • Extend the viewfinder when you attach or remove the shoe cover or the accessory. • The Intelligent accessory shoe for DCR-HC40 and the accessory shoe for DCR-HC30 have a safety device for fixing the installed accessory securely. To connect an accessory, press down and push it to the end, and then tighten the screw. To remove an accessory, loosen the screw, and then press down and pull out the accessory. <p> Tips on the Intelligent accessory shoe</p> <ul style="list-style-type: none"> • The Intelligent accessory shoe supplies power to optional accessories such as a video light, a flash or microphone. • The accessory can be turned on or off as you operate the POWER switch on your camcorder. Refer to the operating instructions of the accessory for details. <p>8 Power zoom lever</p> | <p>9 CAMERA-TAPE, CAMERA-MEMORY, PLAY/EDIT mode lamps (p. 19)</p> <p>10 POWER switch (p. 19)</p> <p>11 Speaker</p> <p>12 DC IN jack cover</p> |
|--|---|

To connect an accessory

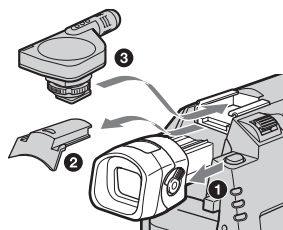

→ continued

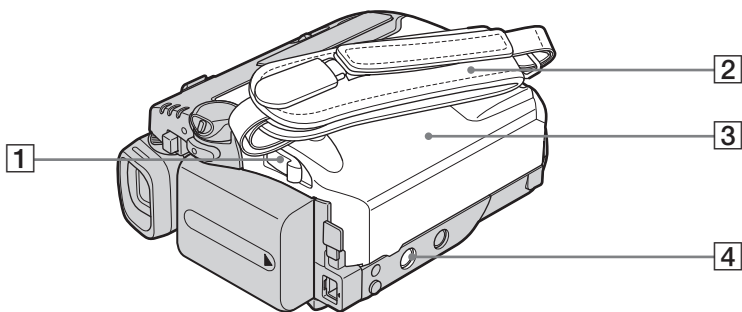

1 OPEN/EJECT lever (p. 23)

2 Strap Belt (p. 4)

3 Cassette lid (p. 23)

4 Tripod receptacle

Make sure that the length of the tripod screw is less than 5.5 mm (7/32 inch). Otherwise, you cannot attach the tripod securely, and the screw may damage your camcorder.

3 Use the Strap Belt as shown below.

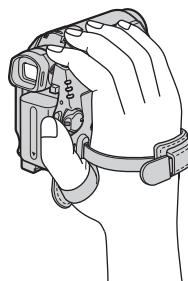

Using the Strap Belt as a wrist strap

It is useful when you carry your camcorder.

1 Open the hook and loop fastener of the hand pad **(1)** and remove it from the ring **(2)**.

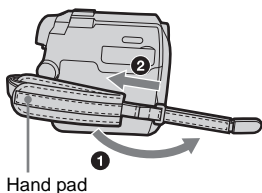

2 Move the hand pad fully to the right **(1)**, then close the hook and loop fastener again **(2)**.

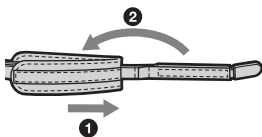

Remote Commander

Remove the insulation sheet before using the Remote Commander.

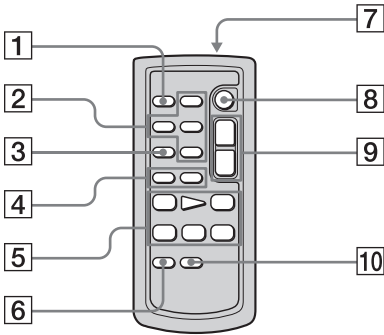

- 1 PHOTO button (p. 31)
- 2 Memory control buttons (Index*, -/+, Memory playback) (p. 52)
- 3 SEARCH M. button* (p. 60, 61)
- 4 ◀◀/▶▶ buttons* (p. 60, 61)
- 5 Video control buttons (Rewind, Playback, Fast-forward, Pause, Stop, Slow) (p. 50)
- 6 ZERO SET MEMORY button* (p. 60)
- 7 Transmitter
After turning on your camcorder, point towards the remote sensor to control your camcorder.
- 8 REC START/STOP (p. 30)
- 9 Power zoom button (p. 29)
- 10 DISPLAY button (p. 60)

* These buttons are not available during Easy Handycam operation.

To remove the insulation sheet

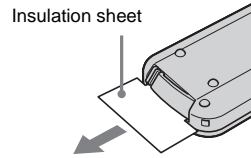

To change the battery

- 1 While pressing on the tab, inset your fingernail into the slit to pull out the battery case.

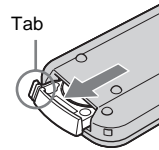

- 2 Remove the button-type lithium battery.

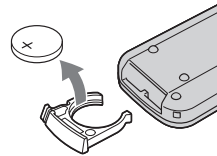

- 3 Place a new button-type lithium battery with the + side facing up.

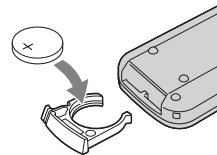

- 4 Insert the battery case back into the Remote Commander until it clicks.

→ continued

WARNING

Battery may explode if mistreated. Do not recharge, disassemble or dispose of in fire.

CAUTION

Danger of explosion if battery is incorrectly replaced.

Replace only with the same or equivalent type recommended by the manufacturer.

Discard used batteries according to the manufacturer's instructions.

Notes on the Remote Commander

- A button-type lithium battery (CR2025) is used in the Remote Commander. Do not use batteries other than CR2025.
- Point the remote sensor away from strong light sources such as direct sunlight or overhead lighting. Otherwise, the Remote Commander may not function properly.
- The Remote Commander may not function properly when the remote sensor is obstructed with a conversion lens (optional).
- When you are operating with the Remote Commander supplied with your camcorder, your VCR may also operate. In that case, select a commander mode other than VTR 2 for your VCR, or cover the sensor of your VCR with black paper.

Indicators for the LCD screen and viewfinder

Following indicators will appear on the LCD screen and viewfinder to indicate the state of your camcorder. Indicators vary depending on your camcorder model.

Example: Indicators in the CAMERA-TAPE mode

Time code (p. 57)/Tape counter (p. 57)/Self-diagnosis (p. 120)/Picture number (p. 53)

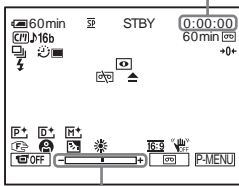

Exposure adjustment scale

Indicators	Meanings
60min	Remaining battery (p. 27)
SP, LP	Recording mode (p. 28)
STBY REC	Recording standby/recording mode
FINE STD	Image quality (p. 32)
1152 640	Image size (p. 32)
320 160	Image size (p. 28)
101 101	Recording folder/playback folder (p. 73)
CM	Cassette Memory (p. 125)
16b	Audio mode (p. 83)
60min	Remaining tape (p. 27)
BRK	Continuous photo recording (Burst) (p. 70)
	Self-timer recording (p. 30, 33)
	Interval recording (p. 76)
	Interval still image recording (p. 77)

Indicators	Meanings
	This indicator appears when you use video flash light (optional).
	Frame recording (p. 76)
	Outputting analog images and sound in digital format (p. 85)
DV IN	DV input (p. 94)
	Zero set memory (p. 60)
	NightShot plus (p. 39)
	Super NightShot plus (p. 39)
	Color Slow Shutter (p. 39)
	Warning (p. 120)
	Picture effect (p. 74)
	Digital effect (p. 43)
	MEMORY MIX (p. 45)
	Manual focus (p. 40)
	PROGRAM AE (p. 64)
	Backlight (p. 37)
	White balance (p. 65)
	16:9 WIDE (p. 68)
	SteadyShot off (p. 69)
	Protect (p. 107)
	Print mark (p. 108)
	Slide show (p. 75)
	LCD backlight off (p. 20)
	Image delete (p. 106)
	PictBridge connecting (p. 109)

Index

Numerics

16:9 WIDE mode 68

A

A/V connecting cable
..... 59, 92, 104
AC Adaptor 16
Accessory shoe 139
Adjusting the viewfinder... 21
Audio dubbing
(AUD DUB CTRL)
..... 104
AUDIO MIX 84, 106
AUDIO MODE 83
Auto shut off function
(A. SHUT OFF) 87
AUTO SHUTTER 66

B

BACK LIGHT (camera).... 37
Battery
Battery Info 17
Battery pack 16
Remaining battery
..... 27, 129
BEEP 20, 87
BLACK FADER 42
BURN DVD 79
BURN VCD 80
BURST 70
Burst (BURST)..... 31, 70
Button-type battery
Camcorder 134
Remote Commander
..... 141

C

CALIBRATION 133
Camera Chroma key
(CAM ← M CHROMA)|
..... 45
Camera settings data display
..... 57
Cassette 23
Cassette Memory 3, 125

Cassette Memory Search
(SEARCH)
..... 47, 60, 61, 80
Charging the battery
Battery pack 16
Pre-installed button-type
battery 134
Clock set
(CLOCK SET) 22, 88
Color Slow Shutter
(COLOR SLOW S) 39
Connection Lamp 137
Customizing Personal
Menu 89

D

Data code
(DATA CODE) 57, 86
Date search 61
Date/time 57
Delete
Deleting pictures 106
DEMO MODE 78
Digital convert function
(A/V → DV OUT) 85
Digital effect
(D.EFFECT) 43, 51
Digital program editing
(PROG.EDIT) 97
DIGITAL ZOOM 68
Direct Access to
“Click to DVD”
See BURN DVD
Direct Access to Video CD
Burn
See BURN VCD
Display
DISPLAY 87
Display indicators 143
DOT FADER 42
Dual sound track tape 84
Dubbing (REC CTRL) 96

E

Easy Handycam 34, 54
EDIT SEARCH 47
END SEARCH 47, 80
Erase
ALL ERASE (Cassette
Memory) 82

ALL ERASE
(still image) 71

Exposure bracketing
(EXP. BRKTG)
See Burst (BURST)

F

FADER 42
FILE NO. 72
Fine (FINE)
See Image quality
(QUALITY)
FLASH LEVEL 67
FLASH MODE 66
Flash motion (FLASH) 43
FLASH SET 66
Flexible spot meter
(SPOT METER) 37
Focus 40
Folder
See NEW FOLDER
See PB FOLDER
See REC FOLDER
FORMAT 72, 126
Frame playback 50
Frame recording
(FRAME REC) 76
Full charge 16

G

Grip Belt
See Strap Belt

I

i.LINK 130
i.LINK cable 92, 97
ID-1/ID-2 system 68
Image protection 107
Image quality
(QUALITY) 32, 71
Image size
(IMAGE SIZE) 32, 71
Index screen 54
“InfoLITHIUM”
battery pack 129
Infrared ray emitter 99
Intelligent accessory
shoe 104, 139
Interval photo recording
(INT. REC-STL) 77

Interval recording
 (INTERVAL REC)76

J

JPEG126

L

LANC.....138

LANGUAGE88

Language
 (LANGUAGE).....25

LCD back light
 (LCD BL LEVEL)84

LCD BACKLIGHT ...20, 137

LCD brightness (LCD
 BRIGHT).....20

LCD COLOR.....85

LCD screen4

LCD/VF SET84

LP (Long Play)
 See Recording mode
 (REC MODE)

Luminance key
 (LUMI. KEY).....43

M

Main sound
 See MULTI-SOUND

Manual exposure
 (EXPOSURE)38

Manual focus.....41

Memory Chroma key
 (M ← CAM CHROMA)
45

Memory Luminance key
 (M ← CAM LUMI.)
45

MEMORY MIX.....45

Memory Overlap
 (OVERLAP).....43

Memory photo.....31, 52

“Memory Stick Duo”
 General
 information126

Inserting.....24

Number of
 pictures28, 32

Menu
 CAMERA SET.....64

EDIT/PLAY79

MEMORY SET70

MENU ROTATE.....87

PICT. APPLI.....74

Selecting items.....62

STANDARD SET83

TIME/LANGU.88

Mirror mode29

Moisture condensation132

MONOTONE42

MOSAIC FADER42

MOVIE SET71

MPEG.....126

MULTI-SOUND84

N

NEW FOLDER72

NightShot Light
 (NS LIGHT).....39, 67

NightShot plus39

NORMAL
 See Burst (BURST)

NTSC.....124

O

OLD MOVIE.....44

Operation Confirmation beep
 See BEEP

P

PAL124

PB FOLDER.....73

Personal Menu
 (P-MENU)62

PictBridge109

Picture effect
 (PICT. EFFECT).....74

Picture search50

Playback (VAR.SPD PB)
 Double speed50

Frame50

Reverse50

Slow50

Playback Zoom
 (PB ZOOM)56

Playing time.....18

Power mode19

PRINT
 See PictBridge109

Print mark108

PROGRAM AE64

Program edit
 (PROG. EDIT)79

R

REC FOLDER73

Rec review48

REC START/STOP26, 50

Recording capacity
 Display27

REMAINING.....71, 86

Recording lamp
 (REC LED).....86

Recording mode
 (REC MODE).....27, 83

Recording time.....18, 28

Remote Commander141

REMOTE CTRL86

Remote sensor138

RESET138

Review26, 31

S

S video59, 92

Self-diagnosis display120

Self-timer recording
 (SELF-TIMER)30, 33

Skip scan50

SLIDE SHOW75

Slow shutter
 (SLOW SHUTTR)44

Smooth transition
 See END SEARCH

SP (Standard Play)
 See Recording mode
 (REC MODE)

SPOT FOCUS.....40

Standard (STANDARD)
 See Image quality
 (QUALITY)

STEADYSHOT69

Stereo/monaural84

STILL.....43

Still image format126

STILL SET.....70

Strap Belt4, 140

Sub sound
 See MULTI-SOUND

Super NightShot plus39

T

Tape counter.....	27
Telephoto	
See Zoom	
Time code.....	27
Title (Cassette Memory)	
TAPE TITLE.....	82
TITL ERASE.....	81
TITLE.....	80
TITLE DISP.....	82
Title search.....	60
TRAIL.....	43
TV color systems.....	124

U

USB Streaming.....	85
USB-CAMERA.....	85
USB-PLY/EDT.....	86
Using abroad.....	124

V

Video head.....	132
VIDEO INPUT.....	85
Viewfinder.....	20
Brightness	
(VF B.LIGHT).....	85
Volume (VOLUME)....	49, 52

W

Warning indicators.....	120
Warning messages.....	120
White balance	
(WHITE BAL.).....	65
WHITE FADER.....	42
Wide angle	
See Zoom	
WIPE.....	42
WORLD TIME.....	88
Wrist strap.....	4, 140
Write-protect tab.....	125, 127

Z

Zero set memory.....	60
Zoom.....	29, 56

<http://www.sony.net/>



Printed on 100% recycled paper using
VOC (Volatile Organic Compound)-free
vegetable oil based ink.

Printed in Japan



3088339110